

Pizza Pans & Supplies





Guide to Pizza Trays -----	236 - 237
Screens-----	238 - 239
Perforated Disks -----	240
CAR Pans -----	239, 241
Trays -----	242 - 243
Tapered/Nesting Pans-----	244 - 247
Straight-Sided Pans -----	248 - 250
Self-Stacking Pans-----	250
Separators-----	251 - 252
Square Pans-----	252
Cake Pans -----	253
Pie Pans-----	253
Heart-Shaped Pans -----	254
Shakers -----	254 - 258
Pizza Stands -----	259 - 261
Pizza Servers -----	261
Pizza Cutters -----	262
Pizza Stones-----	264
Pizza Racks -----	265
Dough Cutters & Scrapers -----	265
Dockers-----	266 - 267
Bubble Poppers -----	267
Peels-----	268 - 271
Pan Grippers-----	272
Delivery Bags -----	273
Dough Boxes -----	274 - 275
Oven Brushes -----	274 - 275
Stirring Paddles-----	274 - 275

A

A Guide to Our Pizza Trays

A) Aluminum Pans

Aluminum pans are available in two weights. Standard Weight pans are 18 ga., .040", 1 mm aluminum and Heavy Weight pans are 14 ga., .064", 1.5 mm aluminum; Heavy Weight pans are 50% heavier than Standard Weight. Standard Weight pans are usually designated with an "A" as either the prefix or suffix in the item number and Heavy Weight pans are usually designated with an "HA" as either the prefix or suffix in the item number. Hand wash is recommended as aluminum is a soft metal that is attacked by detergents with a high alkaline or acidic nature. Hand wash with detergents made specifically for aluminum. Through repeated use aluminum will soften and if scoured, will thin.



Aluminum Pan

B

B) Tin Plate Pans

Tin Plate should be seasoned before use and may need periodic reseasoning. Tin Plate will darken with use and will rust if refrigerated, soaked in water or left unseasoned in damp environments. Wipe dry immediately after hand washing. Tin Plate pans are designated with a "T" as either the prefix or suffix in the item number.

To Season Tin Plate Pans

To season, wash in warm, soapy water and quickly dry. Brush oil on inside and outside surfaces of the pan and bake to a golden or dark brown. When seasoning, bake at regular times and temperatures. Some pans may need a second or third coating before being fully seasoned.

C) Hard Coat Pans

Hard coat pans are made from Heavy Weight aluminum. Perf and SuperPerf hard coat disks are made from Standard Weight aluminum. Hard Coat pans are usually designated with an "HC" as either the prefix or suffix in the item number. Hard coat anodizing is a synergistic electro-chemical process that converts the surface of aluminum into aluminum oxide. The aluminum oxide is a dark color. This finish is hard and will not flake off. However, the aluminum underneath is soft and through repeated use the pan will soften. If scoured, the pan will thin. Hardcoat pans are not non-stick and must be seasoned. Hand wash only.

To Season Hard Coat Pans

Wash and dry the pan thoroughly, wipe oil on the inside and outside surfaces of the pan, and allow to soak in for 30 minutes. Then bake at regular cooking times and temperatures. Do not over bake and do not wash off excess oil, just wipe. The oil residue, and any additional oil added before baking, allows the pan to develop non-stick properties. Remember when cleaning hard anodized aluminum, this is considered an amphoteric coating and will be attacked by solutions of a high alkaline or acidic nature. Do not expose these pans to dishwashers or caustic cleaning solutions. Hand wash with detergents made specifically for aluminum.

Please note:

In our catalog are thousands of different pizza trays and tens of thousands of different combinations of styles, depths, materials and options. **These pans are made to order; they are not stocked.** It is possible that your special order pan has never been made previously or has only been made once or twice. **Consequently, special order pans, once ordered, cannot be cancelled or returned.** Please review and re-confirm the tray you are ordering. If you have any questions, please call and, if necessary, request a sample. **Orders for special order pans cannot be cancelled. Special order pans are not returnable.**



Unseasoned Tin Plate Pan



Seasoned Tin Plate Pan

C



Hard Coat Pan

D) Nibs

Any round or square pizza tray or pan we manufacture, 2" (5.1 cm) deep or less, up to 20" (50.8 cm), can be furnished with Nibs. To order, use the regular item number and add the prefix "N." Also note in the body of the order that the pans should be made with Nibs. The Nibs are approximately 5/8" (15.9 mm) diameter and raise the pizza about 1/8" (3.2 mm) above the surface of the pan. Raising the pizza off the surface allows moisture to escape and a fresher, crispier pizza may result. Pans with Nibs cannot be Perf or SuperPerf. Refer to the tray or pan style for more information and for pricing information.

E) Perf

Any round or square pizza tray or pan less than 21" (53.3 cm) in diameter can be Perforated. To order, use the regular item number and add the suffix or prefix "P." Also note in the body of the order that the pans should be Perforated. These pans cannot be made with Nibs. Perf pans allow the bottom of the pizza to cook faster and can provide a crispier crust. Perf pans can also be used to keep cooked pizzas fresher by allowing moisture to escape. Refer to the tray or pan style for more information and for pricing information. All holes are 3/8" (9.5 mm) diameter.

F) SuperPerf

Any round pan less than 21" (53.3 cm) in diameter can be SuperPerf. To order, use the regular item number and add the suffix SP. Also note in the body of the order that the trays or pans should be SuperPerf. These pans cannot be made with Nibs. For the same diameter, SuperPerf pans have twice as many holes as Perf. SuperPerf allows the bottom of the pizza to cook faster and can provide a crispier crust. SuperPerf can be used to keep cooked pizzas fresher by allowing moisture to escape. All holes 3/8" (9.5 mm) diameter. Refer to the tray or pan style for more information and for pricing information.



Nibs

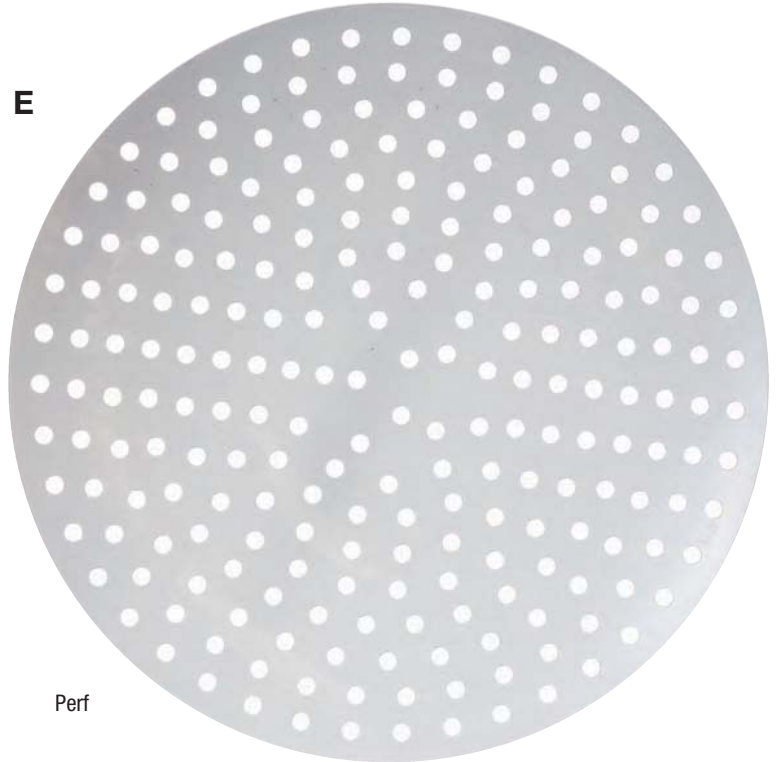

Perf

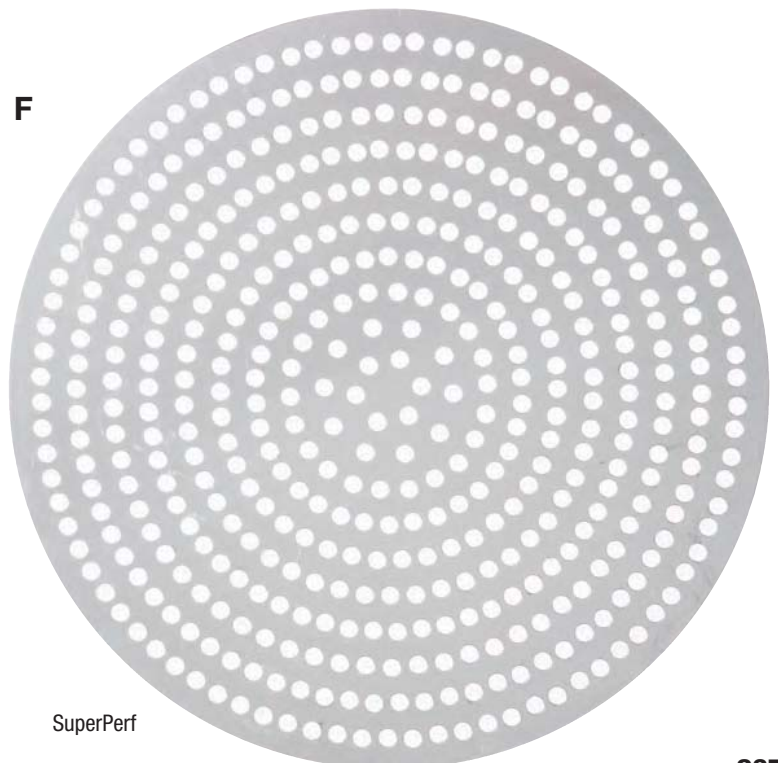

SuperPerf

Perf and SuperPerf Hole Guide			
For pans with a maximum bottom inside diameter:		Number of Holes Standard Perf	Number of Holes Super Perf
5"	(12.7 cm)	10	20
6"	(15.2 cm)	21	42
7"	(17.8 cm)	36	72
8"	(20.3 cm)	57	114
9"	(22.9 cm)	57	114
10"	(25.4 cm)	82	164
11"	(27.9 cm)	113	226
12"	(30.5 cm)	113	226
13"	(33.0 cm)	146	292
14"	(35.5 cm)	185	370
15"	(38.1 cm)	185	370
16"	(40.6 cm)	228	456
17"	(43.2 cm)	275	550
18"	(45.7 cm)	275	550
19"	(48.2 cm)	326	652
20"	(50.8 cm)	379	758
21"	(53.3 cm)	379	758

This box is used throughout the Pizza Tray section to denote what options are available for each series. Please note that these options are made to order and may or may not be in stock.

Perf P	Perforating Pans	Add to List Price	1.80 Ea
SuperPerf SP	DOUBLE the HOLES	Add to List Price	3.20 Ea
Nibs N	Raised Nibs or Bumps	Add to List Price	3.20 Ea

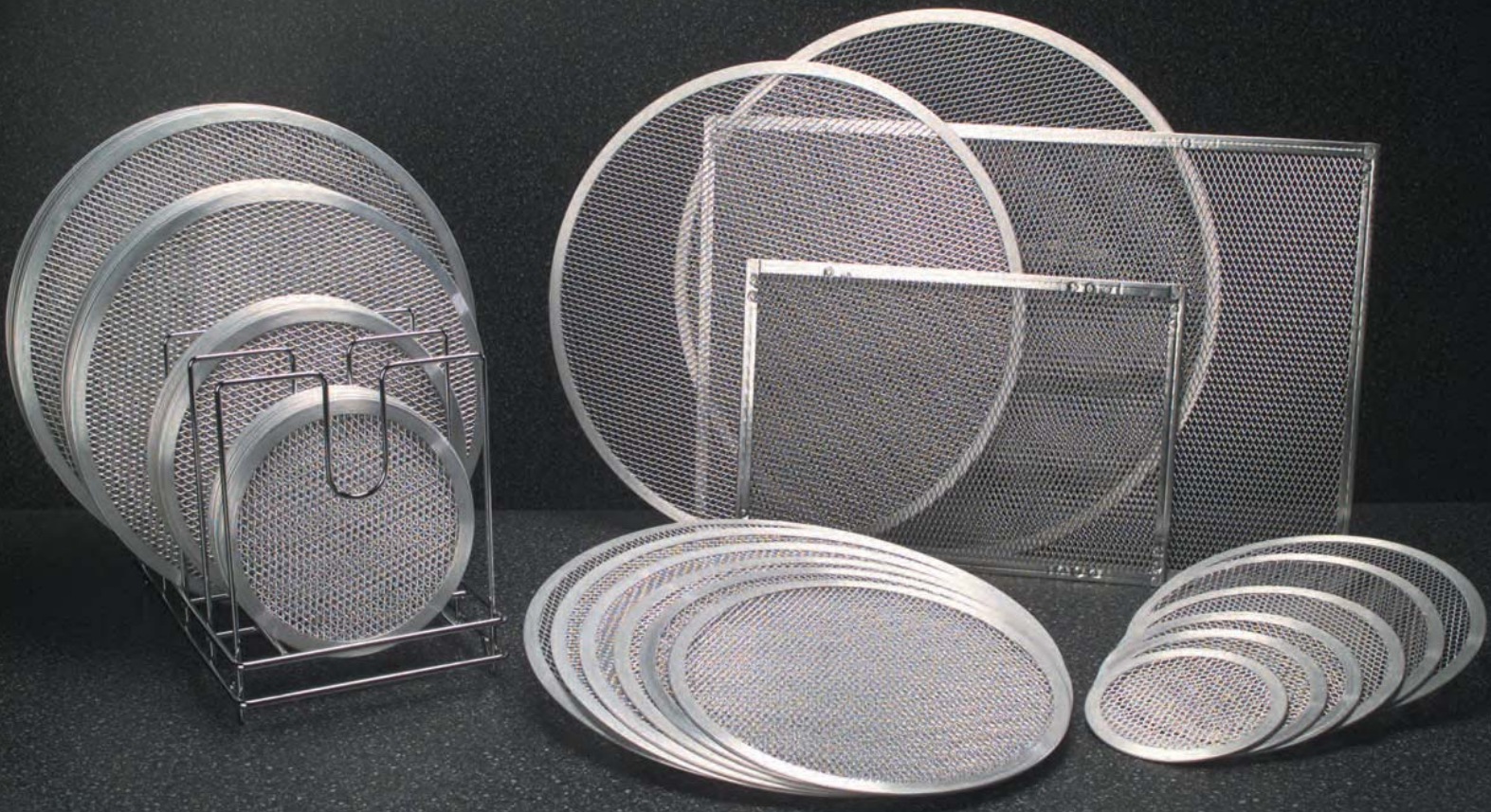

A) Pizza Screens – Heavy-Duty Expanded Aluminum with Seamless Construction



Pizza Screens can produce a more evenly baked crust by allowing for more air circulation.

Heavy-Duty Aluminum

Item No.	Description	Pack	Cu. Ft.	Wt.	List Price
18706	6" OD (15.2 cm)	12/48	0.37	5	3.90 Ea
18707	7" OD (17.8 cm)	12/48	0.80	7	4.00 Ea
18708	8" OD (20.3 cm)	12/48	1.00	7	4.20 Ea
18709	9" OD (22.9 cm)	12/48	1.20	9	4.50 Ea
18710	10" OD (25.4 cm)	12/48	1.50	11	4.80 Ea
18711	11" OD (27.9 cm)	12/48	1.79	12	5.10 Ea
18712	12" OD (30.5 cm)	12/144	2.15	42	5.40 Ea
18713	13" OD (33 cm)	12/48	0.41	17	6.20 Ea
18714	14" OD (35.5 cm)	12/48	1.18	19	6.40 Ea
18715	15" OD (38.1 cm)	12/48	1.19	20	7.50 Ea
18716	16" OD (40.6 cm)	12/48	1.28	20	7.60 Ea
18717	17" OD (43.2 cm)	12/48	1.51	22	8.10 Ea
18718	18" OD (45.7 cm)	12/48	1.70	25	8.80 Ea
18719	19" OD (48.2 cm)	12/48	1.94	28	9.80 Ea
18720	20" OD (50.8 cm)	12/48	2.07	32	10.90 Ea
18724*	24" OD (60.9 cm)	12	1.57	17	29.80 Ea
18728*	28" OD (71.1 cm)	12	1.95	18	57.20 Ea

*Not available in seamless construction.



Pizza Screen Rack

Constructed of 3/16" (.48 cm) chrome plated steel rods. Makes an ideal companion for our popular pizza racks. Holds up to 96 screens from the smallest 6" (15.2 cm) to 28" (71.1 cm). Takes up only 14" L x 9" W (35.6 x 22.9 cm) of table space and stands 10 1/2" H (26.7 cm).

Item No.	Description	Pack	Cu. Ft.	Wt.	List Price
18040	Pizza Screen Rack	2	1.09	7	38.00 Ea

Pizza Screens - Rectangular



Item No.	Description	Pack	Cu. Ft.	Wt.	List Price
18731*	11" L x 16" W (27.9 cm x 40.6 cm) Fits half size bun pan	12	0.75	12	25.00 Ea
18744*	16" L x 24" W (40.6 cm x 60.9 cm) Fits full size bun pan	12	1.08	15	33.00 Ea

*Not available in seamless construction.



B

Mega Screens last five to ten times longer than screens!

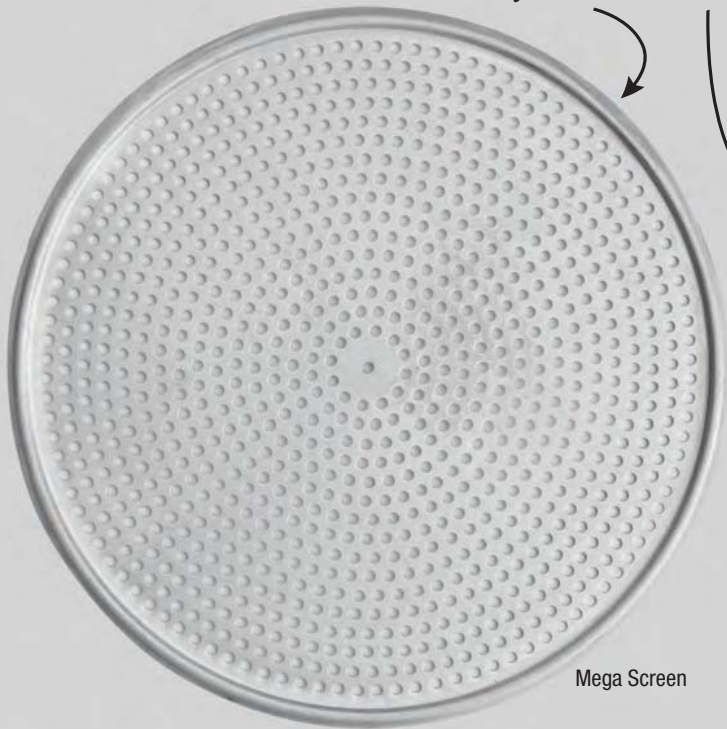

Mega Screen



Mega Hard Coat Anodized Screen

Available in hard coat, too!

C

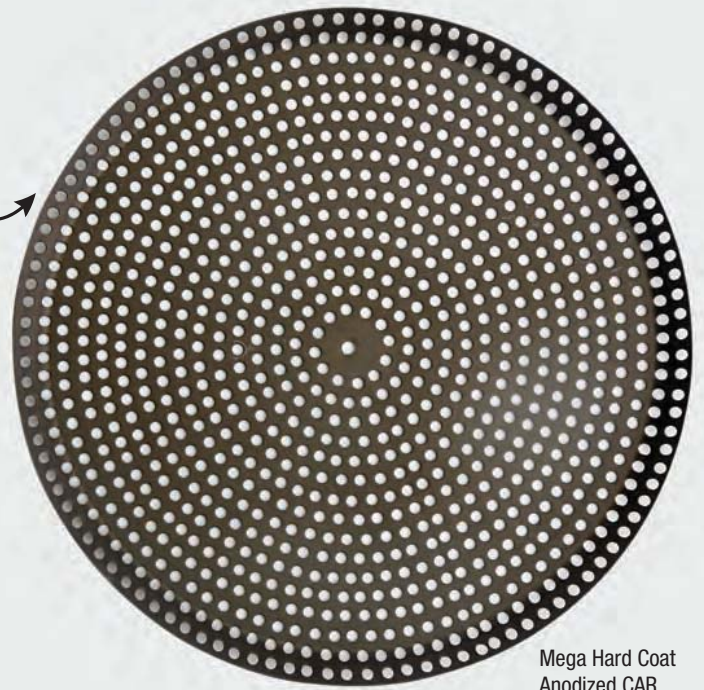

Mega Hard Coat Anodized CAR Pan



Mega CAR Pan

B) Mega Screens - Aluminum 

The only pizza screens tough enough to exceed the high standards of NSF, Mega Screens are the smart choice. Holes and open rims make cleaning a breeze and improve food safety. Available in aluminum or hard coat anodized aluminum, Mega Screens can last 5 to 10 times longer than standard pizza screens. Hard coat Mega screens are the most durable, cost-effective screens for conveyor oven use. Holes are 3/32" (0.24 cm) diameter.

Pan Size	Item No.	Pack	Cu. Ft.	Wt.	List Price
6" ID x 6 3/4" OD (15.2 x 16.0 cm)	28706	12/48	0.50	9	6.00 Ea
7" ID x 7 3/4" OD (17.8 x 18.5 cm)	28707	12/48	0.62	10	6.20 Ea
8" ID x 8 3/4" OD (20.3 x 21.1 cm)	28708	12/48	0.80	12	6.50 Ea
9" ID x 9 3/4" OD (22.9 x 23.6 cm)	28709	12/48	1.00	17	7.00 Ea
10" ID x 10 3/4" OD (25.4 x 26.2 cm)	28710	12/48	0.65	16	7.80 Ea
11" ID x 11 3/4" OD (27.9 x 28.7 cm)	28711	12/48	1.00	18	8.20 Ea
12" ID x 12 3/4" OD (30.5 x 31.2 cm)	28712	12/48	0.88	25	8.80 Ea
13" ID x 13 3/4" OD (33.0 x 33.8 cm)	28713	12/48	1.02	13	10.00 Ea
14" ID x 14 3/4" OD (35.6 x 36.3 cm)	28714	12/48	1.20	15	10.80 Ea
15" ID x 15 3/4" OD (38.1 x 38.9 cm)	28715	12/48	1.20	30	11.60 Ea
16" ID x 16 3/4" OD (40.6 x 41.4 cm)	28716	12/48	1.52	33	13.40 Ea
17" ID x 17 3/4" OD (43.2 x 43.9 cm)	28717	12/48	1.52	34	14.40 Ea
18" ID x 18 3/4" OD (45.7 x 46.5 cm)	28718	12/48	1.90	27	15.40 Ea

Pan Size	Item No.	Pack	Cu. Ft.	Wt.	List Price
6" ID x 6 3/4" OD (15.2 x 16.0 cm)	HC28706	12/72	0.30	16	13.60 Ea
7" ID x 7 3/4" OD (17.8 x 18.5 cm)	HC28707	12/72	0.30	18	15.20 Ea
8" ID x 8 3/4" OD (20.3 x 21.1 cm)	HC28708	12/72	0.46	20	16.80 Ea
9" ID x 9 3/4" OD (22.9 x 23.6 cm)	HC28709	12/48	0.65	22	19.60 Ea
10" ID x 10 3/4" OD (25.4 x 26.2 cm)	HC28710	12/48	0.65	16	22.20 Ea
11" ID x 11 3/4" OD (27.9 x 28.7 cm)	HC28711	12/48	0.65	19	25.00 Ea
12" ID x 12 3/4" OD (30.5 x 31.2 cm)	HC28712	12/48	0.88	25	26.00 Ea
13" ID x 13 3/4" OD (33.0 x 33.8 cm)	HC28713	12/48	0.88	27	26.60 Ea
14" ID x 14 3/4" OD (35.6 x 36.3 cm)	HC28714	12/48	1.20	28	29.00 Ea
15" ID x 15 3/4" OD (38.1 x 38.9 cm)	HC28715	12/48	1.20	30	31.20 Ea
16" ID x 16 3/4" OD (40.6 x 41.4 cm)	HC28716	12/48	1.52	33	36.60 Ea
17" ID x 17 3/4" OD (43.2 x 43.9 cm)	HC28717	12/48	1.52	34	42.00 Ea
18" ID x 18 3/4" OD (45.7 x 46.5 cm)	HC28718	12/48	1.80	41	44.60 Ea

C) Mega CAR Pans - Aluminum 

Made without a rolled edge, sheeted dough can be placed over pan and then cut off with a rolling pin or pie roller. Features 3/32" (0.24 cm) Mega perforations.

Pan Depth 3/4" (1.9 cm)	Item No.	Pack	Cu. Ft.	Wt.	List Price
10" Dia. (25.4 cm)	3CA10	12/48	0.64	16	11.00 Ea
12" Dia. (30.5 cm)	3CA12	12/48	0.90	18	15.00 Ea
14" Dia. (35.6 cm)	3CA14	12/48	1.19	28	18.00 Ea
16" Dia. (40.6 cm)	3CA16	12/48	1.53	34	23.00 Ea
18" Dia. (45.7 cm)	3CA18	12/48	1.90	42	28.00 Ea

Pan Depth 3/4" (1.9 cm)	Item No.	Pack	Cu. Ft.	Wt.	List Price
10" Dia. (25.4 cm)	HC3CA10	24	2.84	18	22.80 Ea
12" Dia. (30.5 cm)	HC3CA12	48	0.90	24	29.10 Ea
14" Dia. (35.6 cm)	HC3CA14	48	1.19	28	34.20 Ea
16" Dia. (40.6 cm)	HC3CA16	48	1.53	34	39.90 Ea
18" Dia. (45.7 cm)	HC3CA18	48	1.91	42	49.70 Ea

Refer to pages 278-279 for care and use instructions.

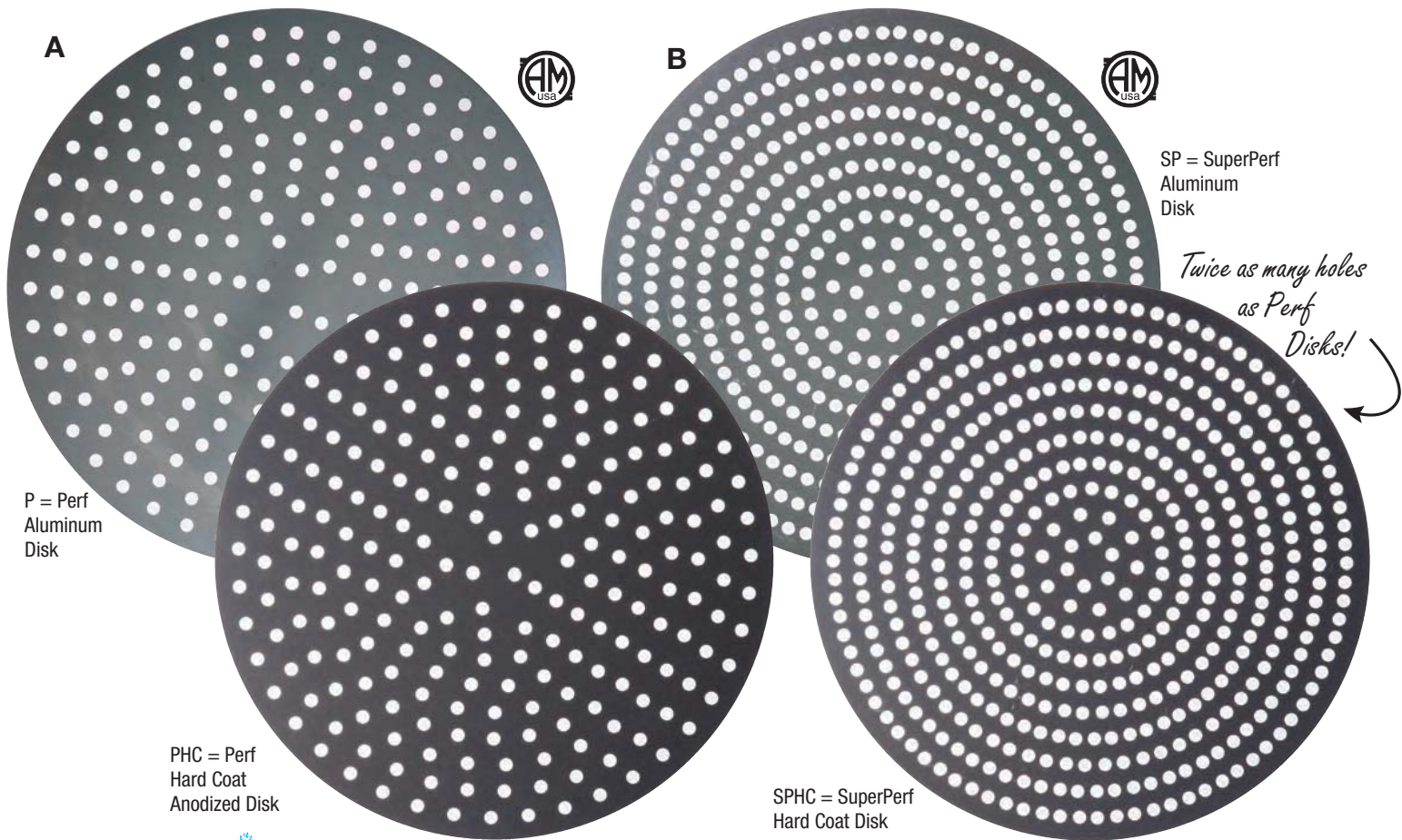

A) Perf Disks



Manufactured from 18 gauge 1 mm aluminum, Perforated Disks can produce a more evenly baked crust by allowing for more air circulation. The edges of the disks and the edges of the holes are unfinished and may be sharp. Holes $\frac{3}{8}$ " (9.5 mm) Diameter.

Disk Size
7" Dia. (17.8 cm)
8" Dia. (20.3 cm)
9" Dia. (22.9 cm)
10" Dia. (25.4 cm)
11" Dia. (27.9 cm)
12" Dia. (30.5 cm)
13" Dia. (33 cm)
14" Dia. (35.5 cm)
15" Dia. (38.1 cm)
16" Dia. (40.6 cm)
17" Dia. (43.2 cm)
18" Dia. (45.7 cm)
19" Dia. (48.2 cm)
20" Dia. (50.8 cm)

Perf Disk - Aluminum (P)

Item No.	Description	Pack	Cu. Ft.	Wt.	List Price
18907P	36 Holes	24	0.19	5	4.00 Ea
18908P	57 Holes	24	0.19	6	4.10 Ea
18909P	57 Holes	24	0.19	7	4.30 Ea
18910P	82 Holes	24	0.28	8	4.50 Ea
18911P	113 Holes	24	0.28	9	5.20 Ea
18912P	113 Holes	24	0.39	11	6.00 Ea
18913P	146 Holes	24	0.39	13	6.40 Ea
18914P	185 Holes	24	0.52	15	7.40 Ea
18915P	185 Holes	24	0.52	17	8.40 Ea
18916P	228 Holes	24	0.67	19	9.50 Ea
18917P	275 Holes	24	0.67	22	10.70 Ea
18918P	275 Holes	24	0.93	24	11.80 Ea
18919P	326 Holes	24	0.93	27	13.20 Ea
18920P	379 Holes	24	0.93	30	14.70 Ea

Perf Disk - Hard Coat (PHC)

Item No.	Description	Pack	Cu. Ft.	Wt.	List Price
18907PHC	36 Holes	24	0.19	5	11.20 Ea
18908PHC	57 Holes	24	0.19	6	11.20 Ea
18909PHC	57 Holes	24	0.19	7	12.30 Ea
18910PHC	82 Holes	24	0.28	8	14.00 Ea
18911PHC	113 Holes	24	0.28	9	16.70 Ea
18912PHC	113 Holes	24	0.39	11	17.70 Ea
18913PHC	146 Holes	24	0.39	13	19.00 Ea
18914PHC	185 Holes	24	0.52	15	20.30 Ea
18915PHC	185 Holes	24	0.52	17	21.30 Ea
18916PHC	228 Holes	24	0.67	19	24.30 Ea
18917PHC	275 Holes	24	0.67	22	27.20 Ea
18918PHC	275 Holes	24	0.93	24	29.70 Ea
18919PHC	326 Holes	24	0.93	27	35.20 Ea
18920PHC	379 Holes	24	0.93	30	37.20 Ea

B) SuperPerf Disks



Disk Size
7" Dia. (17.8 cm)
8" Dia. (20.3 cm)
9" Dia. (22.9 cm)
10" Dia. (25.4 cm)
11" Dia. (27.9 cm)
12" Dia. (30.5 cm)
13" Dia. (33 cm)
14" Dia. (35.5 cm)
15" Dia. (38.1 cm)
16" Dia. (40.6 cm)
17" Dia. (43.2 cm)
18" Dia. (45.7 cm)
19" Dia. (48.2 cm)
20" Dia. (50.8 cm)

SuperPerf Disk - Aluminum (SP)

Item No.	Description	Pack	Cu. Ft.	Wt.	List Price
18907SP	72 Holes	24	0.19	5	5.20 Ea
18908SP	114 Holes	24	0.19	6	5.30 Ea
18909SP	114 Holes	24	0.19	7	5.50 Ea
18910SP	164 Holes	24	0.28	8	5.80 Ea
18911SP	226 Holes	24	0.28	9	6.40 Ea
18912SP	226 Holes	24	0.39	11	7.20 Ea
18913SP	292 Holes	24	0.39	13	7.70 Ea
18914SP	370 Holes	24	0.52	15	8.70 Ea
18915SP	370 Holes	24	0.52	17	9.60 Ea
18916SP	456 Holes	24	0.67	19	10.70 Ea
18917SP	550 Holes	24	0.67	22	12.10 Ea
18918SP	550 Holes	24	0.93	24	13.10 Ea
18919SP	652 Holes	24	0.93	27	14.50 Ea
18920SP	758 Holes	24	0.93	30	16.00 Ea

SuperPerf Disk - Hard Coat (SPHC)

Item No.	Description	Pack	Cu. Ft.	Wt.	List Price
18907SPHC	72 Holes	24	0.19	5	12.70 Ea
18908SPHC	114 Holes	24	0.19	6	12.90 Ea
18909SPHC	114 Holes	24	0.19	7	13.70 Ea
18910SPHC	164 Holes	24	0.28	8	15.60 Ea
18911SPHC	226 Holes	24	0.28	9	18.30 Ea
18912SPHC	226 Holes	24	0.39	11	19.30 Ea
18913SPHC	292 Holes	24	0.39	13	20.80 Ea
18914SPHC	370 Holes	24	0.52	15	21.90 Ea
18915SPHC	370 Holes	24	0.52	17	23.10 Ea
18916SPHC	456 Holes	24	0.67	19	26.20 Ea
18917SPHC	550 Holes	24	0.67	22	29.30 Ea
18918SPHC	550 Holes	24	0.93	24	31.60 Ea
18919SPHC	652 Holes	24	0.93	27	36.60 Ea
18920SPHC	758 Holes	24	0.93	30	38.90 Ea

C



CAR Pans
Heavy Weight 14 Ga., 1.5 mm Aluminum



CAR HC Pans
Hard Coat Anodized – 14 Ga., 1.5 mm Aluminum

Sharp edge also cuts dough!



C) CAR Pans – Tapered/Nesting



CAR pans are made without a rolled edge. The top edge is left unfinished and may be sharp so it can cut dough. Sheeted dough can be placed over the pan and then cut off with a rolling pin or pie roller.

Pan Depth 5/8" (1.6 cm)	
Pan Size	
6" Top OD x 5" Bottom ID	(15.2 x 12.7 cm)
7" Top OD x 6" Bottom ID	(17.8 x 15.2 cm)
7 3/4" Top OD x 6 3/4" Bottom ID	(19.7 x 17.1 cm)
8 1/2" Top OD x 7 1/2" Bottom ID	(21.6 x 19 cm)

Pan Depth 1 1/8" (1.7 cm)	
Pan Size	
9" Top OD x 8" Bottom ID	(22.9 x 20.3 cm)
10" Top OD x 9" Bottom ID	(25.4 x 22.9 cm)
11" Top OD x 10" Bottom ID	(27.9 x 25.4 cm)
12" Top OD x 11" Bottom ID	(30.5 x 27.9 cm)
13" Top OD x 12" Bottom ID	(33 x 30.5 cm)
14" Top OD x 13" Bottom ID	(35.5 x 33 cm)
15" Top OD x 14" Bottom ID	(38.1 x 35.5 cm)
16" Top OD x 15" Bottom ID	(40.6 x 38.1 cm)
17" Top OD x 16" Bottom ID	(43.2 x 40.6 cm)
18" Top OD x 17" Bottom ID	(45.7 x 43.2 cm)
19" Top OD x 18" Bottom ID	(48.3 x 45.7 cm)
20" Top OD x 19" Bottom ID	(50.8 x 48.3 cm)
21" Top OD x 20" Bottom ID	(53.3 x 50.8 cm)
29" Top OD x 28" Bottom ID	(73.6 x 71.1 cm)

CAR Heavy Weight 14 ga., 1.5 mm Aluminum				
Item No.	Pack	Cu. Ft.	Wt.	List Price
CAR6	24	0.19	7	4.40 Ea
CAR7	24	0.19	9	4.70 Ea
CAR8	24	0.19	10	5.10 Ea
CAR9	24	0.19	12	5.60 Ea

Item No.	Pack	Cu. Ft.	Wt.	List Price
CAR95	24	0.28	14	5.90 Ea
CAR10	24	0.28	16	7.00 Ea
CAR11	24	0.28	18	7.50 Ea
CAR12	24	0.39	22	8.50 Ea
CAR13	24	0.39	24	9.80 Ea
CAR14	24	0.52	28	11.20 Ea
CAR15	24	0.52	32	12.70 Ea
CAR16	24	0.67	34	13.80 Ea
CAR17	24	0.67	38	15.70 Ea
CAR18	24	0.93	42	17.30 Ea
CAR19	24	0.93	48	20.30 Ea
CAR20	12	0.93	26	22.40 Ea
CAR21	12	1.68	27	25.20 Ea
CAR29	6	1.95	27	50.50 Ea

CAR HC Hard Coat Anodized 14 ga., 1.5 mm Aluminum				
Item No.	Pack	Cu. Ft.	Wt.	List Price
CAR6HC	24	0.19	7	10.60 Ea
CAR7HC	24	0.19	9	12.00 Ea
CAR8HC	24	0.19	10	13.10 Ea
CAR9HC	24	0.19	12	14.60 Ea

Item No.	Pack	Cu. Ft.	Wt.	List Price
CAR95HC	24	0.28	14	15.00 Ea
CAR10HC	24	0.28	16	17.80 Ea
CAR11HC	24	0.28	18	20.10 Ea
CAR12HC	24	0.39	22	22.40 Ea
CAR13HC	24	0.39	24	22.70 Ea
CAR14HC	24	0.52	28	24.60 Ea
CAR15HC	24	0.52	32	27.40 Ea
CAR16HC	24	0.67	34	31.00 Ea
CAR17HC	24	0.67	38	34.00 Ea
CAR18HC	24	0.93	42	39.20 Ea
CAR19HC	24	0.93	48	41.80 Ea
CAR20HC	12	0.93	52	47.00 Ea
CAR21HC	12	1.68	54	49.20 Ea

Perf P	Perforating Pans	Add to List Price	1.80 Ea
SuperPerf SP	DOUBLE the HOLES	Add to List Price	3.20 Ea
Nibs N	Raised Nibs or Bumps	Add to List Price	3.20 Ea

Refer to pages 278-279 for care and use instructions.



HATP
Heavy Weight
14 Ga. 1.5 mm Aluminum

*Heavy duty aluminum
adds to longer life*



TP
Standard Weight
18 Ga., 1 mm Aluminum



HCTP
Hard Coat Anodized
14 Ga., 1.5 mm Aluminum

A) TP Series Wide Rim Pans 

There's a reason why other pizza supply manufacturers imitate, but never duplicate American Metalcraft's product line. When it comes to durability and reliability in pans, American Metalcraft offers the best value. The TP Series of Pizza Pans is manufactured from heavy duty 14 and 18 gauge aluminum. These gauges of aluminum contribute significantly to a longer life. With so many styles and sizes from which to choose, American Metalcraft has built a solid reputation as a quality manufacturer for the pizza industry since 1947.

Pan Size	Item No.	Pack	Cu. Ft.	Wt.	List Price
6" OD x 4½" ID (15.2 x 11.4 cm)	TP6	12/72	0.36	11	2.70 Ea
7" OD x 5½" ID (17.8 x 14 cm)	TP7	12/72	0.48	14	3.00 Ea
8" OD x 6" ID (20.3 x 16.5 cm)	TP8	12/72	0.60	19	3.50 Ea
9" OD x 7" ID (22.9 x 19.1 cm)	TP9	12/72	0.75	23	4.00 Ea
10" OD x 8" ID (25.4 x 20.3 cm)	TP10	12/72	1.21	29	4.80 Ea
11" OD x 9" ID (27.9 x 22.9 cm)	TP11	12/72	1.40	35	5.40 Ea
12" OD x 10" ID (30.5 x 25.4 cm)	TP12	12/72	1.27	39	5.90 Ea
13" OD x 11" ID (33 x 27.9 cm)	TP13	12/72	1.38	45	6.40 Ea
14" OD x 12" ID (35.5 x 30.5 cm)	TP14	12/36	0.92	27	7.30 Ea
15" OD x 13" ID (38.1 x 33 cm)	TP15	12/36	1.05	31	8.10 Ea
16" OD x 14" ID (40.6 x 35.5 cm)	TP16	12/24	1.14	32	8.60 Ea
17" OD x 15" ID (43.2 x 38.1 cm)	TP17	12/24	1.14	34	9.30 Ea
18" OD x 16" ID (45.7 x 40.6 cm)	TP18	12/24	1.41	36	10.80 Ea
19" OD x 17" ID (48.2 x 43.2 cm)	TP19	12/24	1.70	38	11.60 Ea
20" OD x 18" ID (50.8 x 45.7 cm)	TP20	12/24	1.70	39	13.20 Ea
21" OD x 19" ID (53.3 x 48.3 cm)					
22" OD x 20" ID (55.9 x 50.8 cm)					
23" OD x 21" ID (58.4 x 53.3 cm)					
24" OD x 22" ID (61 x 55.9 cm)					
26" OD x 24" ID (66 x 61 cm)					
28" OD x 26" ID (71.1 x 66 cm)					

TP Standard Weight 18 ga., 1 mm Aluminum					
Item No.	Pack	Cu. Ft.	Wt.	List Price	
TP6	12/72	0.36	11	2.70 Ea	
TP7	12/72	0.48	14	3.00 Ea	
TP8	12/72	0.60	19	3.50 Ea	
TP9	12/72	0.75	23	4.00 Ea	
TP10	12/72	1.21	29	4.80 Ea	
TP11	12/72	1.40	35	5.40 Ea	
TP12	12/72	1.27	39	5.90 Ea	
TP13	12/72	1.38	45	6.40 Ea	
TP14	12/36	0.92	27	7.30 Ea	
TP15	12/36	1.05	31	8.10 Ea	
TP16	12/24	1.14	32	8.60 Ea	
TP17	12/24	1.14	34	9.30 Ea	
TP18	12/24	1.41	36	10.80 Ea	
TP19	12/24	1.70	38	11.60 Ea	
TP20	12/24	1.70	39	13.20 Ea	

HATP Heavy Weight 14 ga. 1.5 mm Aluminum					
Item No.	Pack	Cu. Ft.	Wt.	List Price	
HATP6	96	0.91	26	5.80 Ea	
HATP7	96	0.91	33	5.90 Ea	
HATP8	96	1.20	39	6.30 Ea	
HATP9	96	1.20	53	7.60 Ea	
HATP10	72	1.21	44	8.40 Ea	
HATP11	72	1.70	59	9.80 Ea	
HATP12	60	1.60	59	11.00 Ea	
HATP13	48	1.60	52	11.60 Ea	
HATP14	36	1.00	47	13.60 Ea	
HATP15	36	1.50	52	14.20 Ea	
HATP16	36	1.50	59	16.20 Ea	
HATP17	36	1.50	61	17.40 Ea	
HATP18	24	1.13	50	19.20 Ea	
HATP19	24	1.40	53	19.80 Ea	
HATP20	12	1.02	33	25.20 Ea	
HATP21	12	1.70	35	30.00 Ea	
HATP22	12	1.94	37	34.20 Ea	
HATP23	12	2.02	39	36.40 Ea	
HATP24	12	1.58	44	41.60 Ea	
HATP26	12	1.58	48	46.80 Ea	
HATP28	12	1.95	53	55.80 Ea	

HCTP Hard Coat Anodized 14 ga., 1.5 mm Aluminum					
Item No.	Pack	Cu. Ft.	Wt.	List Price	
HCTP6	96	0.91	26	10.30 Ea	
HCTP7	96	0.91	33	11.00 Ea	
HCTP8	96	1.20	39	12.20 Ea	
HCTP9	96	1.20	53	14.60 Ea	
HCTP10	72	1.21	60	16.60 Ea	
HCTP11	72	1.70	59	19.60 Ea	
HCTP12	60	1.60	59	20.60 Ea	
HCTP13	48	1.60	52	22.20 Ea	
HCTP14	36	1.00	47	25.60 Ea	
HCTP15	36	1.50	52	27.90 Ea	
HCTP16	36	1.50	59	31.80 Ea	
HCTP17	36	1.50	61	35.20 Ea	
HCTP18	24	1.13	50	38.90 Ea	
HCTP19	24	1.40	53	42.60 Ea	
HCTP20	12	1.02	33	53.70 Ea	

Perf P	Perforating Pans	Add to List Price	1.80 Ea
SuperPerf SP	DOUBLE the HOLES	Add to List Price	3.20 Ea
Nibs N	Raised Nibs or Bumps	Add to List Price	3.20 Ea

Refer to pages 278-279 for care and use instructions.



HACTP
Heavy Weight
14 Ga., 1.5 mm Aluminum

CTP
Standard Weight
18 Ga., 1 mm Aluminum



HCCTP
Hard Coat Anodized
14 Ga., 1.5 mm Aluminum



B) CTP Series Coupe Style Pans 

Just like the TP Pizza Pans, these CTP Pans are manufactured from the finest grade of aluminum. It's really pretty simple. The harder materials used in our pans last longer than less expensive alternatives in the marketplace.

Pan Size	CTP Standard Weight 18 Ga., 1 mm Aluminum				
	Item No.	Pack	Cu. Ft.	Wt.	List Price
6" OD x 4½" ID (15.2 x 11.4 cm)	CTP6	12/72	0.36	11	4.20 Ea
7" OD x 5½" ID (17.8 x 14 cm)	CTP7	12/72	0.48	14	4.30 Ea
8" OD x 6½" ID (20.3 x 16.5 cm)	CTP8	12/72	0.60	19	4.70 Ea
9" OD x 7½" ID (22.9 x 19.1 cm)	CTP9	12/72	0.75	23	4.80 Ea
10" OD x 8" ID (25.4 x 20.3 cm)	CTP10	12/72	1.21	29	5.60 Ea
11" OD x 9" ID (27.9 x 22.9 cm)	CTP11	12/72	1.40	35	6.30 Ea
12" OD x 10" ID (30.5 x 25.4 cm)	CTP12	12/72	1.27	39	6.90 Ea
13" OD x 11" ID (33 x 27.9 cm)	CTP13	12/72	1.38	45	7.40 Ea
14" OD x 12" ID (35.5 x 30.5 cm)	CTP14	12/24	0.92	27	8.50 Ea
15" OD x 13" ID (38.1 x 33 cm)	CTP15	12/24	1.05	31	9.20 Ea
16" OD x 14" ID (40.6 x 35.5 cm)	CTP16	12/24	1.14	32	9.80 Ea
17" OD x 15" ID (43.2 x 38.1 cm)	CTP17	12/24	1.14	34	10.70 Ea
18" OD x 16" ID (45.7 x 40.6 cm)	CTP18	12/24	1.41	36	12.00 Ea
19" OD x 17" ID (48.2 x 43.2 cm)	CTP19	12/24	1.70	38	12.80 Ea
20" OD x 18" ID (50.8 x 45.7 cm)					
21" OD x 19" ID (53.3 x 48.2 cm)					
22" OD x 20" ID (55.9 x 50.8 cm)					
23" OD x 21" ID (58.4 x 53.3 cm)					
24" OD x 22" ID (61 x 55.9 cm)					
26" OD x 24" ID (66 x 61 cm)					
28" OD x 26" ID (71.1 x 66 cm)					

Item No.	Pack	Cu. Ft.	Wt.	List Price	HACTP Heavy Weight 14 Ga., 1.5 mm Aluminum				
					Item No.	Pack	Cu. Ft.	Wt.	List Price
HACTP6	96	0.91	26	5.80 Ea					
HACTP7	96	0.91	33	5.90 Ea					
HACTP8	96	1.20	39	6.30 Ea					
HACTP9	96	1.20	53	7.60 Ea					
HACTP10	72	1.70	50	8.40 Ea					
HACTP11	72	1.70	59	9.80 Ea					
HACTP12	60	1.60	59	11.00 Ea					
HACTP13	48	1.60	52	11.60 Ea					
HACTP14	36	1.00	47	13.60 Ea					
HACTP15	36	1.50	52	14.20 Ea					
HACTP16	36	1.50	59	16.20 Ea					
HACTP17	36	1.50	61	17.40 Ea					
HACTP18	24	1.13	50	19.20 Ea					
HACTP19	24	1.40	53	19.80 Ea					
HACTP20	12	1.02	33	25.20 Ea					
HACTP21	12	1.70	35	30.00 Ea					
HACTP22	12	1.94	37	34.20 Ea					
HACTP23	12	2.02	39	36.40 Ea					
HACTP24	12	1.58	44	41.60 Ea					
HACTP26	12	1.58	48	46.80 Ea					
HACTP28	12	1.95	53	55.80 Ea					

Item No.	Pack	Cu. Ft.	Wt.	List Price	HCCTP Hard Coat Anodized 14 Ga., 1.5 mm Aluminum				
					Item No.	Pack	Cu. Ft.	Wt.	List Price
HCCTP6	96	0.91	26	10.30 Ea					
HCCTP7	96	0.91	33	11.00 Ea					
HCCTP8	96	1.20	39	12.20 Ea					
HCCTP9	96	1.20	53	14.70 Ea					
HCCTP10	72	1.70	60	16.60 Ea					
HCCTP11	72	1.70	59	19.70 Ea					
HCCTP12	60	1.60	59	20.60 Ea					
HCCTP13	48	1.60	52	22.20 Ea					
HCCTP14	36	1.00	47	25.60 Ea					
HCCTP15	36	1.50	52	27.90 Ea					
HCCTP16	36	1.50	59	31.80 Ea					
HCCTP17	36	1.50	61	35.20 Ea					
HCCTP18	24	1.13	50	38.90 Ea					
HCCTP19	24	1.40	53	42.60 Ea					
HCCTP20	12	1.02	33	53.60 Ea					

Perf P	Perforating Pans	Add to List Price	1.80 Ea
SuperPerf SP	DOUBLE the HOLES	Add to List Price	3.20 Ea
Nibs N	Raised Nibs or Bumps	Add to List Price	3.20 Ea

Refer to pages 278-279 for care and use instructions.

A



A2000
Standard Weight
18 Ga, 1 mm Aluminum

Pans nest to save space!



HA2000
Heavy Weight
14 Ga, 1.5 mm Aluminum



T2000
Tin Plate
22 Ga,
Tin Plate on Steel



HC2000
Hard Coat Anodized
14 Ga, 1.5 mm Aluminum

A) 2000 Series - Tapered/Nesting



Pan Depth 1/2" (1.3 cm)

Pan Size	
6" Top ID x 5 5/8" Bottom ID	(15.2 x 14.3 cm)
7" Top ID x 6 5/8" Bottom ID	(17.8 x 16.8 cm)
8" Top ID x 7 5/8" Bottom ID	(20.3 x 19.4 cm)
9" Top ID x 8 5/8" Bottom ID	(22.9 x 21.9 cm)
10" Top ID x 9 5/8" Bottom ID	(25.4 x 24.4 cm)
11" Top ID x 10 5/8" Bottom ID	(27.9 x 26.9 cm)
12" Top ID x 11 5/8" Bottom ID	(30.5 x 29.5 cm)
13" Top ID x 12 5/8" Bottom ID	(33 x 32 cm)
14" Top ID x 13 5/8" Bottom ID	(35.5 x 34.6 cm)
15" Top ID x 14 5/8" Bottom ID	(38.1 x 37.1 cm)
16" Top ID x 15 5/8" Bottom ID	(40.6 x 39.7 cm)
17" Top ID x 16 5/8" Bottom ID	(43.2 x 42.2 cm)
18" Top ID x 17 5/8" Bottom ID	(45.7 x 44.7 cm)

A2000 Standard Weight
18 ga., 1 mm Aluminum

Item No.	Pack	Cu. Ft.	Wt.	List Price
A2006	24	0.30	6	5.90 Ea
A2007	24	0.30	8	6.10 Ea
A2008	24	0.30	9	6.30 Ea
A2009	24	0.46	10	6.50 Ea
A2010	24	0.46	14	7.40 Ea
A2011	24	0.67	16	8.10 Ea
A2012	24	0.67	18	8.60 Ea
A2013	24	0.91	20	9.10 Ea
A2014	24	0.91	22	10.70 Ea
A2015	24	1.19	24	11.50 Ea
A2016	24	1.19	28	12.60 Ea
A2017	24	1.50	32	13.20 Ea
A2018	24	1.50	36	14.30 Ea

T2000 Tin Plate
22 ga., Tin Plate on Steel

Item No.	Pack	Cu. Ft.	Wt.	List Price
T2006	24	0.30	8	9.40 Ea
T2007	24	0.30	9	10.80 Ea
T2008	24	0.30	10	11.20 Ea
T2009	24	0.46	12	11.80 Ea
T2010	24	0.46	16	13.80 Ea
T2011	24	0.67	18	14.60 Ea
T2012	24	0.67	22	15.20 Ea
T2013	24	0.91	24	17.00 Ea
T2014	24	0.91	28	18.60 Ea
T2015	24	1.19	32	19.40 Ea
T2016	24	1.19	36	22.40 Ea
T2017	24	1.50	32	24.00 Ea
T2018	24	1.50	36	27.00 Ea

Pan Depth 1/2" (1.3 cm)

Pan Size	
6" Top ID x 5 5/8" Bottom ID	(15.2 x 14.3 cm)
7" Top ID x 6 5/8" Bottom ID	(17.8 x 16.8 cm)
8" Top ID x 7 5/8" Bottom ID	(20.3 x 19.4 cm)
9" Top ID x 8 5/8" Bottom ID	(22.9 x 21.9 cm)
10" Top ID x 9 5/8" Bottom ID	(25.4 x 24.4 cm)
11" Top ID x 10 5/8" Bottom ID	(27.9 x 26.9 cm)
12" Top ID x 11 5/8" Bottom ID	(30.5 x 29.5 cm)
13" Top ID x 12 5/8" Bottom ID	(33 x 32 cm)
14" Top ID x 13 5/8" Bottom ID	(35.5 x 34.6 cm)
15" Top ID x 14 5/8" Bottom ID	(38.1 x 37.1 cm)
16" Top ID x 15 5/8" Bottom ID	(40.6 x 39.7 cm)
17" Top ID x 16 5/8" Bottom ID	(43.2 x 42.2 cm)
18" Top ID x 17 5/8" Bottom ID	(45.7 x 44.7 cm)

HA2000 Heavy Weight
14 ga., 1.5 mm Aluminum

Item No.	Pack	Cu. Ft.	Wt.	List Price
HA2006	24	0.30	8	7.70 Ea
HA2007	24	0.30	10	8.00 Ea
HA2008	24	0.30	12	8.20 Ea
HA2009	24	0.46	16	9.00 Ea
HA2010	24	0.46	20	11.00 Ea
HA2011	24	0.67	24	11.20 Ea
HA2012	24	0.67	26	12.70 Ea
HA2013	24	0.91	28	13.60 Ea
HA2014	24	0.91	32	15.50 Ea
HA2015	24	1.19	36	16.60 Ea
HA2016	24	1.19	40	18.00 Ea
HA2017	24	1.50	46	19.10 Ea
HA2018	24	1.50	52	21.00 Ea

HC2000 Hard Coat Anodized
14 ga., 1.5 mm Aluminum

Item No.	Pack	Cu. Ft.	Wt.	List Price
HC2006	24	0.30	8	13.10 Ea
HC2007	24	0.30	10	15.00 Ea
HC2008	24	0.30	12	15.80 Ea
HC2009	24	0.46	16	18.40 Ea
HC2010	24	0.46	20	21.40 Ea
HC2011	24	0.67	24	24.80 Ea
HC2012	24	0.67	26	25.40 Ea
HC2013	24	0.91	28	27.60 Ea
HC2014	24	0.91	32	29.00 Ea
HC2015	24	1.19	36	29.60 Ea
HC2016	24	1.19	40	33.80 Ea
HC2017	24	1.50	46	40.20 Ea
HC2018	24	1.50	52	43.00 Ea

COVERS Separators (p. 251) and 7000 pans (p. 251) can be used as covers for 2000's.
STACKING 7000 pans (p. 251) are stacking covers for tapered 2000 pans.

Perf P Perforating Pans Add to List Price **1.80 Ea**
SuperPerf SP DOUBLE the HOLES Add to List Price **3.20 Ea**

Refer to pages 278-279 for care and use instructions.

B



ADEP
Standard
Weight 18 Ga,
1 mm Aluminum



HADEP
Heavy Weight
14 Ga,
1.5 mm Aluminum



TDEP
Tin Plate
22 Ga, Tin Plate on Steel



HCDEP
Hard Coat
Anodized
Heavy Weight 14 Ga,
1.5 mm Aluminum

B) DEP Series - Tapered/Nesting



Pan Depth 1" (2.5 cm)

Pan Size	Top ID	Bottom ID	Dimensions (cm)
6"	5 1/4"	5 1/4"	(15.2 x 13.3 cm)
7"	6 1/4"	6 1/4"	(17.8 x 15.9 cm)
8"	7 1/4"	7 1/4"	(20.3 x 18.4 cm)
9"	8 1/4"	8 1/4"	(22.9 x 20.9 cm)
10"	9 1/4"	9 1/4"	(25.4 x 23.5 cm)
11"	10 1/4"	10 1/4"	(27.9 x 26 x cm)
12"	11 1/4"	11 1/4"	(30.5 x 28.6 cm)
13"	12 1/4"	12 1/4"	(33 x 31.1 cm)
14"	13 1/4"	13 1/4"	(35.5 x 33.6 cm)
15"	14 1/4"	14 1/4"	(38.1 x 36.2 cm)
16"	15 1/4"	15 1/4"	(40.6 x 38.7 cm)
17"	16 1/4"	16 1/4"	(43.2 x 41.3 cm)
18"	17 1/4"	17 1/4"	(45.7 x 43.8 cm)

**ADEP Standard Weight
18 ga., 1 mm Aluminum**

Item No.	Pack	Cu. Ft.	Wt.	List Price
ADEP6	24	0.30	7	5.10 Ea
ADEP7	24	0.30	8	5.40 Ea
ADEP8	24	0.30	9	5.50 Ea
ADEP9	24	0.46	10	6.50 Ea
ADEP10	24	0.46	12	7.10 Ea
ADEP11	24	0.67	14	8.20 Ea
ADEP12	24	0.67	18	8.70 Ea
ADEP13	24	0.91	20	9.00 Ea
ADEP14	24	0.91	22	11.30 Ea
ADEP15	24	1.19	24	12.00 Ea
ADEP16	24	1.19	26	12.50 Ea
ADEP17	12	1.50	16	13.30 Ea
ADEP18	12	1.50	19	14.50 Ea

**TDEP Tin Plate
22 ga., Tin Plate on Steel**

Item No.	Pack	Cu. Ft.	Wt.	List Price
TDEP6	12	0.30	6	9.40 Ea
TDEP7	12	0.30	6	10.80 Ea
TDEP8	12	0.30	7	11.20 Ea
TDEP9	12	0.46	8	12.00 Ea
TDEP10	12	0.46	9	13.80 Ea
TDEP11	12	0.67	12	14.60 Ea
TDEP12	12	0.67	13	15.20 Ea
TDEP13	12	0.91	15	17.00 Ea
TDEP14	12	0.91	17	18.60 Ea
TDEP15	12	1.19	18	19.40 Ea
TDEP16	12	1.19	18	22.40 Ea
TDEP17	12	1.50	20	24.00 Ea
TDEP18	12	1.50	22	27.00 Ea

Pan Depth 1" (2.5 cm)

Pan Size	Top ID	Bottom ID	Dimensions (cm)
6"	5 1/4"	5 1/4"	(15.2 x 13.3 cm)
7"	6 1/4"	6 1/4"	(17.8 x 15.9 cm)
8"	7 1/4"	7 1/4"	(20.3 x 18.4 cm)
9"	8 1/4"	8 1/4"	(22.9 x 20.9 cm)
10"	9 1/4"	9 1/4"	(25.4 x 23.5 cm)
11"	10 1/4"	10 1/4"	(27.9 x 26 cm)
12"	11 1/4"	11 1/4"	(30.5 x 28.6 cm)
13"	12 1/4"	12 1/4"	(33 x 31.1 cm)
14"	13 1/4"	13 1/4"	(35.5 x 33.6 cm)
15"	14 1/4"	14 1/4"	(38.1 x 36.2 cm)
16"	15 1/4"	15 1/4"	(40.6 x 38.7 cm)
17"	16 1/4"	16 1/4"	(43.2 x 41.3 cm)
18"	17 1/4"	17 1/4"	(45.7 x 43.8 cm)
19"	18 1/4"	18 1/4"	(48.3 x 46.4 cm)

**HADEP Heavy Weight
14 ga., 1.5 mm Aluminum**

Item No.	Pack	Cu. Ft.	Wt.	List Price
HADEP6	24	0.30	9	8.40 Ea
HADEP7	24	0.30	10	9.40 Ea
HADEP8	24	0.46	11	9.60 Ea
HADEP9	24	0.46	13	10.00 Ea
HADEP10	24	0.67	17	12.30 Ea
HADEP11	24	0.67	18	13.00 Ea
HADEP12	24	0.67	22	13.50 Ea
HADEP13	24	0.91	24	14.00 Ea
HADEP14	24	1.19	28	15.80 Ea
HADEP15	24	1.19	32	16.60 Ea
HADEP16	24	1.50	36	17.90 Ea
HADEP17	12	1.13	20	21.00 Ea
HADEP18	12	1.39	21	23.10 Ea
HADEP19	12	1.39	23	25.20 Ea

**HCDEP Hard Coat Anodized
14 ga., 1.5 mm Aluminum**

Item No.	Pack	Cu. Ft.	Wt.	List Price
HCDEP6	24	0.46	9	14.20 Ea
HCDEP7	24	0.46	10	16.00 Ea
HCDEP8	24	0.46	11	17.00 Ea
HCDEP9	24	0.46	13	19.60 Ea
HCDEP10	24	0.67	17	24.00 Ea
HCDEP11	24	0.67	18	26.00 Ea
HCDEP12	24	0.91	22	29.40 Ea
HCDEP13	24	0.91	24	30.00 Ea
HCDEP14	24	1.19	28	32.20 Ea
HCDEP15	24	1.19	32	33.00 Ea
HCDEP16	24	1.50	36	36.00 Ea
HCDEP17	12	1.50	20	40.40 Ea
HCDEP18	12	1.39	21	44.00 Ea

COVERS Separators (p. 251) and 7000 pans (p. 251) can be used as covers for DEP's.

STACKING 7000 pans (p. 251) are stacking covers for tapered DEP pans.

Perf P Perforating Pans Add to List Price **1.80 Ea**

SuperPerf SP DOUBLE the HOLES Add to List Price **3.20 Ea**

Refer to pages 278-279 for care and use instructions.

A



A9000
Standard Weight
18 Ga., 1 mm Aluminum



T9000
Tin Plate on Steel
22 Gauge
Shown stacking with
7000 Series Rim Pans



A) 9000 Series - Tapered/Nesting



Pan Depth 1 1/8" (2.8 cm)

Pan Size	
5" Top ID x 4 3/8" Bottom ID	(12.7 x 11.1 cm)
5 1/2" Top ID x 5" Bottom ID	(13.9 x 12.7 cm)

Pan Depth 1 1/2" (3.8 cm)

Pan Size	
6" Top ID x 5 1/2" Bottom ID	(15.2 x 13.9 cm)
7" Top ID x 6 1/4" Bottom ID	(17.8 x 15.8 cm)
8" Top ID x 7 1/4" Bottom ID	(20.3 x 18.4 cm)
9" Top ID x 8 1/4" Bottom ID	(22.8 x 20.9 cm)
10" Top ID x 9 1/4" Bottom ID	(25.4 x 23.5 cm)
11" Top ID x 10 1/4" Bottom ID	(27.9 x 26 cm)
12" Top ID x 11 1/4" Bottom ID	(30.5 x 28.6 cm)
13" Top ID x 12 1/4" Bottom ID	(33 x 31.1 cm)
14" Top ID x 13 1/4" Bottom ID	(35.5 x 33.6 cm)
15" Top ID x 14 1/4" Bottom ID	(38.1 x 36.2 cm)
16" Top ID x 15 1/4" Bottom ID	(40.6 x 38.7 cm)
17" Top ID x 16 1/4" Bottom ID	(43.2 x 41.3 cm)
18" Top ID x 17 1/4" Bottom ID	(45.7 x 43.8 cm)

Pan Depth 2" (5.1 cm)

Pan Size	
6" Top ID x 5" Bottom ID	(15.2 x 12.7 cm)
7" Top ID x 6" Bottom ID	(17.8 x 15.2 cm)
8" Top ID x 7" Bottom ID	(20.3 x 17.8 cm)
9" Top ID x 8" Bottom ID	(22.8 x 20.3 cm)
10" Top ID x 9" Bottom ID	(25.4 x 22.8 cm)
11" Top ID x 10" Bottom ID	(27.9 x 25.4 cm)
12" Top ID x 11" Bottom ID	(30.5 x 27.9 cm)
13" Top ID x 12" Bottom ID	(33 x 30.5 cm)
14" Top ID x 13" Bottom ID	(35.5 x 33 cm)
15" Top ID x 14" Bottom ID	(38.1 x 35.5 cm)
16" Top ID x 15" Bottom ID	(40.6 x 38.1 cm)
17" Top ID x 16" Bottom ID	(43.2 x 40.6 cm)
18" Top ID x 17" Bottom ID	(45.7 x 43.2 cm)

**A9000 Standard Weight
18 ga., 1 mm Aluminum**

Item No.	Pack	Cu. Ft.	Wt.	List Price
A9005	24	0.30	6	6.30 Ea
A9006	24	0.30	7	6.60 Ea

Item No.	Pack	Cu. Ft.	Wt.	List Price
A90671.5	24	0.30	8	6.70 Ea
A90071.5	24	0.30	9	7.00 Ea
A90081.5	24	0.46	10	7.70 Ea
A90091.5	24	0.46	12	8.20 Ea
A90101.5	24	0.67	15	9.00 Ea
A90111.5	24	0.67	17	10.20 Ea
A90121.5	24	0.91	20	10.80 Ea
A90131.5	24	0.91	22	12.00 Ea
A90141.5	24	1.19	24	12.70 Ea
A90151.5	12	1.50	13	13.50 Ea
A90161.5	12	1.50	15	14.70 Ea

Item No.	Pack	Cu. Ft.	Wt.	List Price
A90672	24	0.46	8	6.80 Ea
A90072	24	0.46	9	7.20 Ea
A90082	24	1.00	10	8.00 Ea
A90092	24	1.00	12	8.50 Ea
A90102	24	1.00	15	9.30 Ea
A90112	24	1.00	18	10.40 Ea
A90122	24	1.00	20	11.00 Ea
A90132	24	1.59	22	12.20 Ea
A90142	24	1.59	24	13.10 Ea
A90152	12	1.50	13	13.70 Ea
A90162	12	1.50	15	15.20 Ea

**T9000 Tin Plate
22 ga. Tin Plate on Steel**

Item No.	Pack	Cu. Ft.	Wt.	List Price
T9005	24	0.30	12	10.80 Ea
T9006	24	0.30	14	11.40 Ea

Item No.	Pack	Cu. Ft.	Wt.	List Price
T90671.5	24	0.30	18	12.00 Ea
T90071.5	24	0.30	20	13.00 Ea
T90081.5	24	0.46	22	14.40 Ea
T90091.5	24	0.46	24	15.00 Ea
T90101.5	24	0.67	28	16.00 Ea
T90111.5	24	0.67	32	17.00 Ea
T90121.5	24	0.91	35	17.40 Ea
T90131.5	24	0.91	38	18.40 Ea
T90141.5	24	1.19	44	20.00 Ea
T90151.5	12	1.50	24	21.20 Ea
T90161.5	12	1.50	27	22.40 Ea
T90171.5	12	1.50	30	23.80 Ea
T90181.5	12	1.50	32	25.60 Ea

Item No.	Pack	Cu. Ft.	Wt.	List Price
T90672	24	0.30	18	12.10 Ea
T90072	24	0.30	20	13.20 Ea
T90082	24	0.30	22	14.60 Ea
T90092	24	0.46	24	15.40 Ea
T90102	24	0.46	28	16.20 Ea
T90112	24	0.67	32	17.00 Ea
T90122	24	0.67	35	17.60 Ea
T90132	24	0.91	38	18.60 Ea
T90142	24	0.91	44	20.40 Ea
T90152	12	1.19	24	21.40 Ea
T90162	12	1.19	27	22.60 Ea
T90172	12	1.50	31	24.00 Ea
T90182	12	1.50	36	25.80 Ea

COVERS Separators (p. 251) and 7000 pans (p. 251) can be used as covers for 9000's.
STACKING 7000 pans (p. 251) are stacking covers for tapered 9000 pans.

Perf P Perforating Pans Add to List Price **1.80 Ea**
SuperPerf SP DOUBLE the HOLES Add to List Price **3.20 Ea**

Refer to pages 278-279 for care and use instructions.



HA9000
Heavy Weight
14 Ga, 1.5 mm Aluminum



HC9000
Hard Coat Anodized
Heavy Weight 14 Ga, 1.5 mm Aluminum

B) 9000 Series - Tapered/Nesting



Pan Depth 1 1/8" (2.8 cm)

Pan Size	
5" Top ID x 4 3/8" Bottom ID	(12.7 x 11.1 cm)
5 1/2" Top ID x 5" Bottom ID	(13.9 x 12.7 cm)

Pan Depth 1 1/2" (3.8 cm)

Pan Size	
6" Top ID x 5 1/2" Bottom ID	(15.2 x 13.9 cm)
7" Top ID x 6 1/4" Bottom ID	(17.8 x 15.8 cm)
8" Top ID x 7 1/4" Bottom ID	(20.3 x 18.4 cm)
9" Top ID x 8 1/4" Bottom ID	(22.8 x 20.9 cm)
10" Top ID x 9 1/4" Bottom ID	(25.4 x 23.5 cm)
11" Top ID x 10 1/4" Bottom ID	(27.9 x 26 cm)
12" Top ID x 11 1/4" Bottom ID	(30.5 x 28.6 cm)
13" Top ID x 12 1/4" Bottom ID	(33 x 31.1 cm)
14" Top ID x 13 1/4" Bottom ID	(35.5 x 33.6 cm)
15" Top ID x 14 1/4" Bottom ID	(38.1 x 36.2 cm)
16" Top ID x 15 1/4" Bottom ID	(40.6 x 38.7 cm)
17" Top ID x 16 1/4" Bottom ID	(43.2 x 41.3 cm)
18" Top ID x 17 1/4" Bottom ID	(45.7 x 43.8 cm)

Pan Depth 2" (5.1 cm)

Pan Size	
6" Top ID x 5" Bottom ID	(15.2 x 12.7 cm)
7" Top ID x 6" Bottom ID	(17.8 x 15.2 cm)
8" Top ID x 7" Bottom ID	(20.3 x 17.8 cm)
9" Top ID x 8" Bottom ID	(22.8 x 20.3 cm)
10" Top ID x 9" Bottom ID	(25.4 x 22.8 cm)
11" Top ID x 10" Bottom ID	(27.9 x 25.4 cm)
12" Top ID x 11" Bottom ID	(30.5 x 27.9 cm)
13" Top ID x 12" Bottom ID	(33 x 30.5 cm)
14" Top ID x 13" Bottom ID	(35.5 x 33 cm)
15" Top ID x 14" Bottom ID	(38.1 x 35.5 cm)
16" Top ID x 15" Bottom ID	(40.6 x 38.1 cm)
17" Top ID x 16" Bottom ID	(43.2 x 40.6 cm)
18" Top ID x 17" Bottom ID	(45.7 x 43.2 cm)

**HA9000 Heavy Weight
14 ga., 1.5 mm Aluminum**

Item No.	Pack	Cu. Ft.	Wt.	List Price
HA9005	24	0.30	8	8.20 Ea
HA9006	24	0.30	9	8.40 Ea

Item No.	Pack	Cu. Ft.	Wt.	List Price
HA90671.5	24	0.30	10	9.50 Ea
HA90071.5	24	0.30	12	10.10 Ea
HA90081.5	24	0.46	16	10.30 Ea
HA90091.5	24	0.46	20	10.90 Ea
HA90101.5	24	0.67	26	12.60 Ea
HA90111.5	24	0.67	30	13.60 Ea
HA90121.5	24	0.91	35	14.50 Ea
HA90131.5	24	0.91	36	15.00 Ea
HA90141.5	24	1.19	38	17.10 Ea
HA90151.5	12	1.50	22	18.20 Ea
HA90161.5	12	1.50	24	20.30 Ea
HA90171.5	12	1.50	28	21.30 Ea
HA90181.5	12	1.50	32	23.90 Ea

**HC9000 Hard Coat Anodized
14 ga., 1.5 mm Aluminum**

Item No.	Pack	Cu. Ft.	Wt.	List Price
HC9005	24	0.30	8	13.80 Ea
HC9006	24	0.30	9	14.40 Ea

Item No.	Pack	Cu. Ft.	Wt.	List Price
HC90671.5	24	0.30	10	15.20 Ea
HC90071.5	24	0.30	12	17.80 Ea
HC90081.5	24	0.46	16	18.40 Ea
HC90091.5	24	0.46	20	21.00 Ea
HC90101.5	24	0.67	26	24.40 Ea
HC90111.5	24	0.67	30	27.80 Ea
HC90121.5	24	0.91	35	29.00 Ea
HC90131.5	24	0.91	36	30.40 Ea
HC90141.5	24	1.19	38	33.00 Ea
HC90151.5	12	1.50	22	36.40 Ea
HC90161.5	12	1.50	24	39.40 Ea
HC90171.5	12	1.50	28	49.80 Ea
HC90181.5	12	1.50	32	55.80 Ea

COVERS Separators (p. 251) and 7000 pans (p. 251) can be used as covers for 9000's.
STACKING 7000 pans (p. 251) are stacking covers for tapered 9000 pans.

Perf P Perforating Pans Add to List Price **1.80 Ea**
SuperPerf SP DOUBLE the HOLES Add to List Price **3.20 Ea**

Refer to pages 278-279 for care and use instructions.

A



A4000
Standard Weight
18 Ga, 1 mm Aluminum



HC4000
Hard Coat Anodized
14 Ga, 1.5 mm
Aluminum



HA4000
Heavy Weight Aluminum
14 Ga, 1.5 mm



A4004
Aluminum 18 Ga, 1 mm



T4000
Tin Plate
22 Ga, Tin Plate on Steel

A) 4000 Series – Straight-Sided



Pan Depth 3/4" (1.9 cm)

Pan Size	
4" ID	(10.2 cm)

A4000 Standard Weight
18 ga., 1 mm Aluminum

Item No.	Pack	Cu. Ft.	Wt.	List Price
A4004	48	0.91	6	4.80 Ea

Pan Depth 1" (2.5 cm)

Pan Size	
6" ID	(15.2 cm)
7" ID	(17.8 cm)
8" ID	(20.3 cm)
9" ID	(22.9 cm)
10" ID	(25.4 cm)
11" ID	(27.9 cm)
12" ID	(30.5 cm)
13" ID	(33 cm)
14" ID	(35.5 cm)
15" ID	(38.1 cm)
16" ID	(40.6 cm)

Item No.	Pack	Cu. Ft.	Wt.	List Price
A4006	24	1.19	6	6.20 Ea
A4007	24	2.78	8	6.60 Ea
A4008	24	2.78	9	6.80 Ea
A4009	24	2.78	10	7.30 Ea
A4010	24	2.78	14	8.20 Ea
A4011	24	2.78	16	8.80 Ea
A4012	12	1.13	9	9.30 Ea
A4013	12	1.13	10	9.70 Ea
A4014	12	1.88	11	12.00 Ea
A4015	12	1.88	12	12.50 Ea
A4016	24	1.88	28	12.90 Ea

T4000 Tin Plate
22 ga., Tin Plate on Steel

Item No.	Pack	Cu. Ft.	Wt.	List Price
T4006	24	1.19	10	10.40 Ea
T4007	24	2.78	12	11.60 Ea
T4008	24	2.78	14	12.60 Ea
T4009	24	2.78	16	13.00 Ea
T4010	24	2.78	20	14.20 Ea
T4011	24	2.78	24	14.80 Ea
T4012	24	1.13	26	16.20 Ea
T4013	12	1.13	15	18.20 Ea
T4014	12	1.88	17	19.40 Ea
T4015	12	1.88	19	21.20 Ea
T4016	12	1.88	22	22.40 Ea

Pan Depth 1" (2.5 cm)

Pan Size	
6" ID	(15.2 cm)
7" ID	(17.8 cm)
8" ID	(20.3 cm)
9" ID	(22.9 cm)
10" ID	(25.4 cm)
11" ID	(27.9 cm)
12" ID	(30.5 cm)
13" ID	(33 cm)
14" ID	(35.5 cm)
15" ID	(38.1 cm)
16" ID	(40.6 cm)
17" ID	(43.2 cm)
18" ID	(45.7 cm)
19" ID	(48.3 cm)
20" ID	(50.8 cm)

HA4000 Heavy Weight Aluminum
14 ga., 1.5 mm Aluminum

Item No.	Pack	Cu. Ft.	Wt.	List Price
HA4006	24	1.19	8	8.00 Ea
HA4007	24	2.78	10	8.20 Ea
HA4008	24	2.78	12	8.50 Ea
HA4009	24	2.78	16	9.00 Ea
HA4010	24	2.78	20	11.50 Ea
HA4011	24	2.78	24	12.00 Ea
HA4012	24	1.13	26	12.80 Ea
HA4013	12	1.13	14	14.00 Ea
HA4014	12	1.88	16	15.10 Ea
HA4015	12	1.88	18	16.00 Ea
HA4016	12	1.88	20	17.80 Ea
HA4017	12	1.88	23	18.90 Ea
HA4018	12	1.85	26	20.40 Ea
HA4019	12	1.85	30	23.00 Ea
HA4020	12	2.78	35	32.00 Ea

HC4000 Hard Coat Anodized
14 ga., 1.5 mm Aluminum

Item No.	Pack	Cu. Ft.	Wt.	List Price
HC4006	24	1.19	8	14.80 Ea
HC4007	24	2.78	10	16.20 Ea
HC4008	24	2.78	12	18.20 Ea
HC4009	24	2.78	16	20.20 Ea
HC4010	24	2.78	20	24.60 Ea
HC4011	24	2.78	24	27.80 Ea
HC4012	24	1.13	26	28.80 Ea
HC4013	12	1.13	14	30.60 Ea
HC4014	12	1.88	16	33.20 Ea
HC4015	12	1.88	18	35.60 Ea
HC4016	12	1.88	20	41.40 Ea
HC4017	12	1.88	23	46.60 Ea
HC4018	12	1.85	26	50.00 Ea
HC4019	12	1.85	30	52.00 Ea
HC4020	12	2.78	35	62.20 Ea

COVERS Separators (p. 251) can be used as covers for 4000's.
STACKING Separators (p. 251) can be used as stacking covers for stacking 8000's.

Perf P Perforating Pans Add to List Price **1.80 Ea**
SuperPerf SP DOUBLE the HOLES Add to List Price **3.20 Ea**

Refer to pages 278-279 for care and use instructions.

B



A8000
Standard Weight
18 Ga, 1 mm Aluminum



T8000
Tin Plate
22 Ga, Tin Plate on Steel

HA8000
Heavy Weight
14 Ga, 1.5 mm Aluminum



HC8000
Hard Coat Anodized
Heavy Weight
14 Ga, 1.5 mm
Aluminum



B) 8000 Series – Straight-Sided

Pan Depth 1½" (3.8 cm)

Pan Size	
6" ID	(15.2 cm)
7" ID	(17.8 cm)
8" ID	(20.3 cm)
9" ID	(22.9 cm)
10" ID	(25.4 cm)
12" ID	(30.5 cm)

A8000 Standard Weight
18 ga., 1 mm Aluminum

Item No.	Pack	Cu. Ft.	Wt.	List Price
A80061.5	24	1.19	8	7.40 Ea
A80071.5	24	1.50	9	7.80 Ea
A80081.5	24	2.78	10	8.50 Ea
A80091.5	24	2.78	12	8.70 Ea
A80101.5	24	2.78	15	10.00 Ea
A80121.5	12	2.78	10	11.00 Ea

T8000 Tin Plate
22 Ga., Tin Plate on Steel

Item No.	Pack	Cu. Ft.	Wt.	List Price
T80061.5	24	1.19	14	12.00 Ea
T80071.5	24	1.50	18	13.20 Ea
T80081.5	24	2.78	22	15.00 Ea
T80091.5	24	2.78	24	15.40 Ea
T80101.5	24	2.78	28	16.20 Ea
T80121.5	12	2.78	17	19.20 Ea

Pan Depth 2" (5.1 cm)

Pan Size	
6" ID	(15.2 cm)
7" ID	(17.8 cm)
8" ID	(20.3 cm)
9" ID	(22.9 cm)
10" ID	(25.4 cm)
11" ID	(27.9 cm)
12" ID	(30.5 cm)
13" ID	(33 cm)
14" ID	(35.5 cm)
16" ID	(40.6 cm)

Item No.	Pack	Cu. Ft.	Wt.	List Price
A80062	12	1.19	4	7.80 Ea
A80072	12	1.19	5	8.20 Ea
A80082	12	2.78	5	9.20 Ea
A80092	12	2.78	6	9.30 Ea
A80102	12	2.78	8	10.50 Ea
A80112	12	2.78	9	11.50 Ea
A80122	12	2.78	10	12.00 Ea
A80132	12	3.38	11	12.40 Ea
A80142	12	3.38	12	14.30 Ea
A80162	12	4.63	15	15.70 Ea

Item No.	Pack	Cu. Ft.	Wt.	List Price
T80062	12	1.19	7	12.20 Ea
T80072	12	1.19	9	13.60 Ea
T80082	12	2.78	11	15.20 Ea
T80092	12	2.78	12	15.60 Ea
T80102	12	2.78	14	17.00 Ea
T80112	12	2.78	16	17.80 Ea
T80122	12	2.78	17	19.40 Ea
T80132	12	3.38	19	20.60 Ea
T80142	12	3.38	22	22.60 Ea
T80162	12	4.63	27	25.80 Ea

Pan Depth 1½" (3.8 cm)

Pan Size	
6" ID	(15.2 cm)
7" ID	(17.8 cm)
8" ID	(20.3 cm)
9" ID	(22.9 cm)
10" ID	(25.4 cm)
12" ID	(30.5 cm)

HA8000 Heavy Weight
14 ga., 1.5 mm Aluminum

Item No.	Pack	Cu. Ft.	Wt.	List Price
HA80061.5	24	1.19	10	9.40 Ea
HA80071.5	24	1.50	12	10.00 Ea
HA80081.5	24	2.78	15	10.60 Ea
HA80091.5	24	2.78	17	10.90 Ea
HA80101.5	24	2.78	20	12.60 Ea
HA80121.5	12	2.78	13	14.00 Ea

HC8000 Hard Coat Anodized
14 ga., 1.5 mm Aluminum

Item No.	Pack	Cu. Ft.	Wt.	List Price
HC80061.5	24	1.19	10	16.20 Ea
HC80071.5	24	1.50	12	18.20 Ea
HC80081.5	24	2.78	15	20.40 Ea
HC80091.5	24	2.78	17	22.40 Ea
HC80101.5	24	2.78	20	26.80 Ea
HC80121.5	12	2.78	13	31.00 Ea

Pan Depth 2" (5.1 cm)

Pan Size	
6" ID	(15.2 cm)
7" ID	(17.8 cm)
8" ID	(20.3 cm)
9" ID	(22.9 cm)
10" ID	(25.4 cm)
11" ID	(27.9 cm)
12" ID	(30.5 cm)
13" ID	(33 cm)
14" ID	(35.5 cm)
16" ID	(40.6 cm)
18" ID	(45.7 cm)

Item No.	Pack	Cu. Ft.	Wt.	List Price
HA80062	12	1.19	5	10.20 Ea
HA80072	12	1.19	6	10.30 Ea
HA80082	12	2.78	8	11.40 Ea
HA80092	12	2.78	10	11.80 Ea
HA80102	12	2.78	11	13.80 Ea
HA80112	12	2.78	13	14.00 Ea
HA80122	12	2.78	15	15.60 Ea
HA80132	12	3.38	17	16.00 Ea
HA80142	12	3.38	18	18.20 Ea
HA80162	12	4.63	23	21.20 Ea
HA80182	12	4.63	28	25.80 Ea

Item No.	Pack	Cu. Ft.	Wt.	List Price
HC80062	12	1.19	5	16.40 Ea
HC80072	12	1.19	6	18.40 Ea
HC80082	12	2.78	8	20.60 Ea
HC80092	12	2.78	10	23.00 Ea
HC80102	12	2.78	11	26.80 Ea
HC80112	12	2.78	13	31.00 Ea
HC80122	12	2.78	15	32.00 Ea
HC80132	12	3.38	17	33.60 Ea
HC80142	12	3.38	18	38.60 Ea
HC80162	12	4.63	23	48.00 Ea
HC80182	12	4.63	28	54.80 Ea

A



All pans are 1½" deep with 1" inside pan when stacked. (3.8 x 2.54 cm)
Bottom of one pan nests ½" into the top of the pan below.

HA5100
Heavy Weight
14 Ga, 1.5 mm
Aluminum



HC5100
Hard Coat
Anodized
Heavy Weight
14 Ga, 1.5 mm
Aluminum



B



All pans are 2" deep with 1½" inside pan when stacked. (5 x 3.8 cm)
Bottom of one pan nests ½" into the top of the pan below.

HA5000
Heavy Weight
14 Ga, 1.5 mm
Aluminum



HC5000
Hard Coat Anodized
Heavy Weight
14 Ga, 1.5 mm Aluminum



A) 5100 Series - Straight-Sided - Self-Stacking



Pan Depth 1½" (3.8 cm)

Pan Size	
6" Top ID x 5⅞" Bottom ID x 1½" Inside	(15.2 x 14.9 x 3.8 cm)
7" Top ID x 6⅞" Bottom ID x 1½" Inside	(17.8 x 17.5 x 3.8 cm)
8" Top ID x 7⅞" Bottom ID x 1½" Inside	(20.3 x 20 x 3.8 cm)
9" Top ID x 8⅞" Bottom ID x 1½" Inside	22.9 x 22.5 x 3.8 cm)
10" Top ID x 9⅞" Bottom ID x 1½" Inside	(25.4 x 25.1 x 3.8 cm)
11" Top ID x 10⅞" Bottom ID x 1½" Inside	(27.9 x 27.6 x 3.8 cm)
12" Top ID x 11⅞" Bottom ID x 1½" Inside	(30.5 x 30.1 x 3.8 cm)
13" Top ID x 12⅞" Bottom ID x 1½" Inside	(33 x 32.7 x 3.8 cm)
14" Top ID x 13⅞" Bottom ID x 1½" Inside	(35.5 x 35.2 x 3.8 cm)
15" Top ID x 14⅞" Bottom ID x 1½" Inside	(38.1 x 37.8 x 3.8 cm)
16" Top ID x 15⅞" Bottom ID x 1½" Inside	(40.6 x 40.3 x 3.8 cm)

**HA5100 Heavy Weight
14 ga., 1.5 mm Aluminum**

Item No.	Pack	Cu. Ft.	Wt.	List Price
HA5106	24	1.50	10	10.30 Ea
HA5107	24	1.50	12	11.10 Ea
HA5108	24	2.78	16	11.50 Ea
HA5109	24	2.78	20	12.20 Ea
HA5110	24	2.78	26	13.50 Ea
HA5111	12	2.78	15	14.70 Ea
HA5112	12	2.78	17	15.40 Ea
HA5113	12	3.38	18	16.40 Ea
HA5114	12	3.38	19	18.20 Ea
HA5115	12	3.38	22	19.30 Ea
HA5116	12	3.38	24	22.00 Ea

**HC5100 Hard Coat Anodized
14 ga., 1.5 mm Aluminum**

Item No.	Pack	Cu. Ft.	Wt.	List Price
HC5106	24	1.50	10	18.40 Ea
HC5107	24	2.78	12	19.80 Ea
HC5108	24	2.78	16	21.80 Ea
HC5109	24	2.78	20	25.00 Ea
HC5110	24	2.78	26	28.40 Ea
HC5111	12	2.78	15	31.40 Ea
HC5112	12	2.78	17	32.60 Ea
HC5113	12	3.38	18	37.20 Ea
HC5114	12	3.38	19	38.00 Ea
HC5115	12	3.38	22	40.80 Ea
HC5116	12	3.38	24	47.40 Ea

B) 5000 Series - Straight-Sided - Self-Stacking



Pan Depth 2" (5.1 cm)

Pan Size	
6" Top ID x 5⅞" Bottom ID x 2" Inside	(15.2 x 14.9 x 5.1 cm)
7" Top ID x 6⅞" Bottom ID x 2" Inside	(17.8 x 17.5 x 5.1 cm)
8" Top ID x 7⅞" Bottom ID x 2" Inside	(20.3 x 20 x 5.1 cm)
9" Top ID x 8⅞" Bottom ID x 2" Inside	(22.9 x 22.5 x 5.1 cm)
10" Top ID x 9⅞" Bottom ID x 2" Inside	(25.4 x 25.1 x 5.1 cm)
11" Top ID x 10⅞" Bottom ID x 2" Inside	(27.9 x 27.6 x 5.1 cm)
12" Top ID x 11⅞" Bottom ID x 2" Inside	(30.5 x 30.1 x 5.1 cm)
13" Top ID x 12⅞" Bottom ID x 2" Inside	(33 x 32.7 x 5.1 cm)
14" Top ID x 13⅞" Bottom ID x 2" Inside	(35.5 x 35.2 x 5.1 cm)
15" Top ID x 14⅞" Bottom ID x 2" Inside	(38.1 x 37.8 x 5.1 cm)
16" Top ID x 15⅞" Bottom ID x 2" Inside	(40.6 x 40.3 x 5.1 cm)
17" Top ID x 16⅞" Bottom ID x 2" Inside	(43.2 x 42.9 x 5.1 cm)
18" Top ID x 17⅞" Bottom ID x 2" Inside	(45.7 x 45.4 x 5.1 cm)

**HA5000 Heavy Weight
14 ga., 1.5 mm Aluminum**

Item No.	Pack	Cu. Ft.	Wt.	List Price
HA5006	24	1.50	10	11.10 Ea
HA5007	24	2.78	12	12.10 Ea
HA5008	24	2.78	16	12.50 Ea
HA5009	24	2.78	20	12.90 Ea
HA5010	24	2.78	26	14.50 Ea
HA5011	12	2.78	15	15.60 Ea
HA5012	12	2.78	17	16.60 Ea
HA5013	12	3.38	18	17.70 Ea
HA5014	12	3.38	19	19.20 Ea
HA5015	12	3.38	22	21.20 Ea
HA5016	12	3.38	24	23.50 Ea
HA5017	12	4.63	27	26.00 Ea
HA5018	12	4.63	27	28.10 Ea

**HC5000 Hard Coat Anodized
14 ga., 1.5 mm Aluminum**

Item No.	Pack	Cu. Ft.	Wt.	List Price
HC5006	12	4.63	5	18.80 Ea
HC5007	12	4.63	6	20.40 Ea
HC5008	24	1.50	16	22.40 Ea
HC5009	24	2.78	20	25.80 Ea
HC5010	24	2.78	26	29.60 Ea
HC5011	24	2.78	30	32.80 Ea
HC5012	24	2.78	34	34.00 Ea
HC5013	12	2.78	18	38.00 Ea
HC5014	12	2.78	19	40.60 Ea
HC5015	12	3.38	22	47.20 Ea
HC5016	12	3.38	24	52.60 Ea
HC5017	12	3.38	27	61.60 Ea
HC5018	12	3.38	27	65.00 Ea

COVERS Separators (p. 251) and 7000 pans (p. 251) can be used as covers for 5000's and 5100's.

Perf P SuperPerf SP Perforating Pans DOUBLE the HOLES

Add to List Price **1.80 Ea**
Add to List Price **3.20 Ea**



C) Round Separators

Round separators shown stacking with our 9000 series pans. To choose the correct separator, measure the top outside diameter of your pan and then find a separator that is a minimum of 2" larger. Note: Unfinished edges.

Standard Weight 18 ga., 1 mm Aluminum

Item No.	Description	Pack	Cu. Ft.	Wt.	List Price
18907	7" OD (17.8 cm) Aluminum Disk Separates 5" (12.7 cm) Diameter and smaller pans	24	0.19	4	2.20 Ea
18908	8" OD (20.3 cm) Aluminum Disk Separates 6" (15.2 cm) Diameter and smaller pans	24	0.19	6	2.30 Ea
18909	9" OD (22.9 cm) Aluminum Disk Separates 7" (17.8 cm) Diameter and smaller pans	24	0.19	7	2.50 Ea
18910	10" OD (25.4 cm) Aluminum Disk Separates 8" (20.3 cm) Diameter and smaller pans	24	0.28	8	2.70 Ea
18911	11" OD (27.9 cm) Aluminum Disk Separates 9" (22.9 cm) Diameter and smaller pans	24	0.28	9	3.40 Ea
18912	12" OD (30.5 cm) Aluminum Disk Separates 10" (25.4 cm) Diameter and smaller pans	24	0.39	13	4.20 Ea
18913	13" OD (33 cm) Aluminum Disk Separates 11" (27.9 cm) Diameter and smaller pans	24	0.39	15	4.60 Ea
18914	14" OD (35.5 cm) Aluminum Disk Separates 12" (30.5 cm) Diameter and smaller pans	24	0.52	17	5.70 Ea
18915	15" OD (38.1 cm) Aluminum Disk Separates 13" (33 cm) Diameter and smaller pans	24	0.52	19	6.60 Ea
18916	16" OD (40.6 cm) Aluminum Disk Separates 14" (35.6 cm) Diameter and smaller pans	24	0.67	22	7.70 Ea
18917	17" OD (43.2 cm) Aluminum Disk Separates 15" (38.1 cm) Diameter and smaller pans	24	0.67	22	8.90 Ea
18918	18" OD (45.7 cm) Aluminum Disk Separates 16" (40.6 cm) Diameter and smaller pans	24	0.93	24	10.00 Ea
18919	19" OD (48.2 cm) Aluminum Disk Separates 17" (43.2 cm) Diameter and smaller pans	24	0.93	27	11.40 Ea
18920	20" OD (50.8 cm) Aluminum Disk Separates 18" (45.7 cm) Diameter and smaller pans	24	0.93	30	12.90 Ea

D) 7000 Series

7000 Series are stacking covers for DEP, 2000 and 9000 pans, covers for the top of a stack for 5000 and 5100 pans, or as covers only for 4000 and 8000 pans. Only tapered pans can be made to stack with 7000's.

If you know the AM item number of your pan, look for it on the list. If you don't know the number, measure the top inside diameter of your pan and find the 7000 series cover with the largest smaller ID.

7000 Standard Weight 18 ga., 1 mm Aluminum

Item No.	Description	Pack	Cu. Ft.	Wt.	List Price
7006	5 $\frac{3}{4}$ " ID x 7 $\frac{1}{2}$ " OD x $\frac{1}{4}$ " Deep, for 6" ID pans (14.6 cm x 19 cm x .6 cm, for 15.2 cm pans) Cover only for 4006, 8006, 5006, 5106, Stacking Cover for DEP6, 2006, 9067	24	0.30	6	5.60 Ea
7007	6 $\frac{3}{4}$ " ID x 8 $\frac{1}{2}$ " OD x $\frac{1}{4}$ " Deep, For 7" ID pans (17.1 cm x 21.6 cm x .6 cm for 17.8 cm pans) Cover only for 4007, 8007, 5007, 5107, Stacking Cover for DEP7, 2007, 9007	24	0.30	8	5.90 Ea
7008	7 $\frac{3}{4}$ " ID x 9 $\frac{1}{2}$ " OD x $\frac{1}{4}$ " Deep, For 8" ID pans (19.7 cm x 24.1 cm x .6 cm for 20.3 cm pans) Cover only for 4008, 8008, 5008, 5108, Stacking Cover for DEP8, 2008, 9008	24	0.46	10	6.30 Ea
7009	8 $\frac{3}{4}$ " ID x 10 $\frac{1}{2}$ " OD x $\frac{1}{4}$ " Deep, For 9" ID pans (22.2 cm x 26.7 cm x .6 cm for 22.9 cm pans) Cover only for 4009, 8009, 5009, 5109, Stacking Cover for DEP9, 2009, 9009	24	0.46	12	6.50 Ea
7010	9 $\frac{3}{4}$ " ID x 11 $\frac{1}{2}$ " OD x $\frac{1}{4}$ " Deep, For 10" ID pans (24.8 cm x 29.2 cm x .6 cm for 25.4 cm pans) Cover only for 4010, 8010, 5010, 5110, Stacking Cover for DEP10, 2010, 9010	24	0.67	14	6.90 Ea
7011	10 $\frac{3}{4}$ " ID x 12 $\frac{1}{2}$ " OD x $\frac{1}{4}$ " Deep, For 11" ID pans (27.3 cm x 31.7 cm x .6 cm for 27.9 cm pans) Cover only for 4011, 8011, 5011, 5111, Stacking Cover for DEP11, 2011, 9011	24	0.67	16	7.70 Ea
7012	11 $\frac{3}{4}$ " ID x 13 $\frac{1}{2}$ " OD x $\frac{1}{4}$ " Deep, For 12" ID pans (29.8 cm x 34.3 cm x .6 cm for 30.5 cm pans) Cover only for 4012, 8012, 5012, 5112, Stacking Cover for DEP12, 2012, 9012	24	0.91	20	8.40 Ea
7013	12 $\frac{3}{4}$ " ID x 14 $\frac{1}{2}$ " OD x $\frac{1}{4}$ " Deep, For 13" ID pans (32.4 cm x 36.8 cm x .6 cm for 33 cm pans) Cover only for 4013, 8013, 5013, 5113, Stacking Cover for DEP13, 2013, 9013	24	0.91	22	9.10 Ea
7014	13 $\frac{3}{4}$ " ID x 15 $\frac{1}{2}$ " OD x $\frac{1}{4}$ " Deep, For 14" ID pans (34.9 cm x 39.4 cm x .6 cm for 35.6 cm pans) Cover only for 4014, 8014, 5014, 5114, Stacking Cover for DEP14, 2014, 9014	24	1.19	24	10.40 Ea
7015	14 $\frac{3}{4}$ " ID x 16 $\frac{1}{2}$ " OD x $\frac{1}{4}$ " Deep, For 15" ID pans (37.5 cm x 41.9 cm x .6 cm for 38.1 cm pans) Cover only for 4015, 8015, 5015, 5115, Stacking Cover for DEP15, 2015, 9015	24	1.19	26	10.90 Ea
7016	15 $\frac{3}{4}$ " ID x 17 $\frac{1}{2}$ " OD x $\frac{1}{4}$ " Deep, For 16" ID pans (40 cm x 44.5 cm x .6 cm for 40.6 cm pans) Cover only for 4016, 8016, 5016, 5116, Stacking Cover for DEP16, 2016, 9016	24	1.50	30	11.40 Ea
7017	16 $\frac{3}{4}$ " ID x 18 $\frac{1}{2}$ " OD x $\frac{1}{4}$ " Deep, For 17" ID pans (42.5 cm x 47 cm x .6 cm for 43.2 cm pans) Cover only for 4017, Stacking Cover for DEP17, 2017, 9017	24	1.50	34	12.60 Ea
7018	17 $\frac{3}{4}$ " ID x 19 $\frac{1}{2}$ " OD x $\frac{1}{4}$ " Deep, For 18" ID pans (45.1 cm x 49.5 cm x .6 cm for 45.7 cm pans) Cover only for 4018, 5018, 8018, Stacking Cover for DEP18, 2018, 9018	24	1.85	40	15.40 Ea



A) Square Deep Dish Pans



Heavy weight 14 Ga., 1.5 mm aluminum, straight-sided. Square pans can be perforated with the same round pattern used on all perf pans. Seamless corners and beads.

Pan Depth 1" (2.5 cm)

Pan Size	
6" Sq.	(5.2 cm)
8" Sq.	(20.3 cm)
10" Sq.	(25.4 cm)
12" Sq.	(30.5 cm)
14" Sq.	(35.6 cm)
16" Sq.	(40.6 cm)

Aluminum

Item No.	Pack	Cu. Ft.	Wt.	List Price
SQ610	24	1.19	9	11.80 Ea
SQ810	24	1.50	14	14.90 Ea
SQ1010	24	2.78	21	18.00 Ea
SQ1210	24	2.78	29	21.60 Ea
SQ1410	12	1.19	19	26.00 Ea
SQ1610	12	1.50	23	33.00 Ea

Hard Coat Anodized (Not pictured)

Item No.	Pack	Cu. Ft.	Wt.	List Price
HCSQ610	24	1.19	9	17.00 Ea
HCSQ810	24	1.50	14	22.40 Ea
HCSQ1010	24	2.78	21	29.20 Ea
HCSQ1210	24	2.78	29	36.40 Ea
HCSQ1410	12	1.19	19	44.60 Ea
HCSQ1610	12	1.50	23	53.40 Ea

Pan Depth 1½" (3.8 cm)

Pan Size	
6" Sq.	(15.2 cm)
8" Sq.	(20.3 cm)
10" Sq.	(25.4 cm)
12" Sq.	(30.5 cm)
14" Sq.	(35.6 cm)
16" Sq.	(40.6 cm)

Item No.	Pack	Cu. Ft.	Wt.	List Price
SQ615	24	1.50	11	12.60 Ea
SQ815	24	2.31	17	16.00 Ea
SQ1015	24	2.78	24	20.00 Ea
SQ1215	24	2.78	32	22.50 Ea
SQ1415	12	3.38	21	27.00 Ea
SQ1615	12	3.38	25	33.60 Ea

Item No.	Pack	Cu. Ft.	Wt.	List Price
HCSQ615	24	1.50	11	17.60 Ea
HCSQ815	24	2.31	17	23.20 Ea
HCSQ1015	24	2.78	24	31.00 Ea
HCSQ1215	24	2.78	32	40.20 Ea
HCSQ1415	12	3.38	21	46.00 Ea
HCSQ1615	12	3.38	25	57.80 Ea

Pan Depth 2" (5.1 cm)

Pan Size	
6" Sq.	(15.2 cm)
8" Sq.	(20.3 cm)
10" Sq.	(25.4 cm)
12" Sq.	(30.5 cm)
14" Sq.	(35.6 cm)
16" Sq.	(40.6 cm)

Item No.	Pack	Cu. Ft.	Wt.	List Price
SQ620	12	1.50	6	13.00 Ea
SQ820	12	1.88	10	16.60 Ea
SQ1020	12	2.78	14	20.60 Ea
SQ1220	12	2.78	18	22.90 Ea
SQ1420	12	3.38	23	27.80 Ea
SQ1620	12	4.63	28	34.40 Ea

Item No.	Pack	Cu. Ft.	Wt.	List Price
HCSQ620	12	1.50	6	18.60 Ea
HCSQ820	12	1.88	10	24.80 Ea
HCSQ1020	12	2.78	14	32.00 Ea
HCSQ1220	12	2.78	18	41.80 Ea
HCSQ1420	12	3.38	23	48.40 Ea
HCSQ1620	12	4.63	28	58.20 Ea

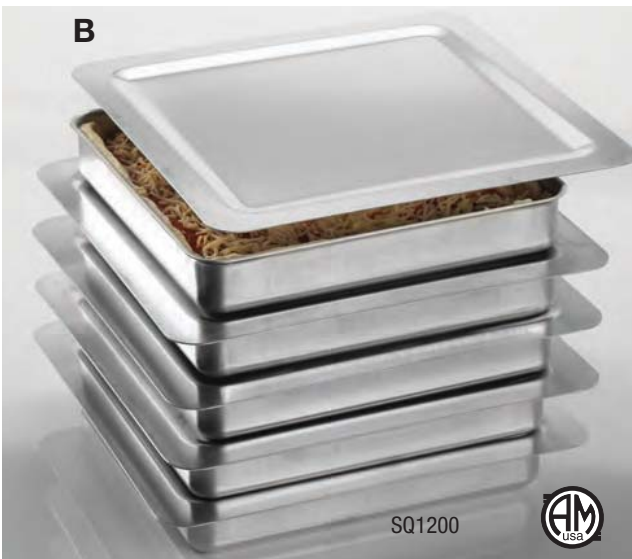

B) Square Separators



Heavy weight 14 Ga., 1.5 mm aluminum. Square separators can be perforated with the same round pattern used on all perf pans. Sanitary seamless construction. Use as serving pan, cover and stacking cover for the 1", 1½" and 2" deep square pans.

Item No.	Description	Pack	Cu. Ft.	Wt.	List Price
SQ600	8½" Sq. (20.3 cm) for 6" (15.2 cm) pan	24	0.19	11	10.50 Ea
SQ800	10½" Sq. (26.7 cm) for 8" (20.3 cm) pan	24	0.28	17	14.10 Ea
SQ1000	12½" Sq. (31.8 cm) for 10" (25.4 cm) pan	24	0.39	24	16.40 Ea
SQ1200	14½" Sq. (36.8 cm) for 12" (30.5 cm) pan	24	0.52	32	21.00 Ea
SQ1400	16½" Sq. (41.9 cm) for 14" (35.6 cm) pan	24	0.67	41	25.40 Ea
SQ1600	18½" Sq. (47 cm) for 16" (40.5 cm) pan	24	0.93	50	32.60 Ea

Perf P Perforating Pans Add to List Price **1.80** Ea

C) Straight-Sided Aluminum Cake Pan Sets

Item No.	Description	Pack	Cu. Ft.	Wt.	List Price
A80012	2" Deep 18 Ga., 1 mm Set includes 1 Each 6", 8", 10", 12", 14" and 16" (1 Each 15.2, 20.3, 25.4, 30.5, 35.6 and 40.6 cm x 5.1 deep)	2	1.19	6	65.00 Set
HA80012	2" Deep 14 Ga., 1.5 mm Set includes 1 Each 6", 8", 10", 12", 14" and 16" (1 Each 15.2, 20.3, 25.4, 30.5, 35.6 and 40.6 cm x 5.1 deep)	2	1.19	8	82.00 Set
3801	3" Deep 14 Ga., 1.5 mm Set includes 1 Each 6", 8", 10", 12" and 14" (1 Each 15.2, 20.3, 25.4, 30.5 and 35.6 cm x 7.6 deep)	2	1.19	5	83.00 Set

D) Round Aluminum Cake Pans

Heavy Weight 14 Ga, 1.5 mm Aluminum, 3" Deep.

Item No.	Description	Pack	Cu. Ft.	Wt.	List Price
3806	6" ID x 3" Deep (15.2 x 7.6 cm)	12	1.50	15	11.80 Ea
3807	7" ID x 3" Deep (17.8 x 7.6 cm)	12	1.52	15	13.00 Ea
3808	8" ID x 3" Deep (20.3 x 7.6 cm)	12	1.55	15	14.20 Ea
3809	9" ID x 3" Deep (22.9 x 7.6 cm)	6	1.61	5	16.00 Ea
3810	10" ID x 3" Deep (25.4 x 7.6 cm)	6	1.61	6	18.00 Ea
3812	12" ID x 3" Deep (30.5 x 7.6 cm)	6	2.39	7	20.60 Ea
3813	13" ID x 3" Deep (33 x 7.6 cm)	6	3.00	9	22.20 Ea
3814	14" ID x 3" Deep (35.6 x 7.6 cm)	6	3.41	11	25.00 Ea

E) Standard Aluminum Pie Pans

Item No.	Description	Pack	Cu. Ft.	Wt.	List Price
475	4" Dia. x 3/4" Deep (10.2 cm x 1.9 cm)	24	0.30	6	6.00 Ea
744	7" Top OD x 6" Top ID x 5 1/2" Bottom ID x 5/8" Deep (17.8 cm x 15.2 cm x 14 cm x 1.6 cm)	24	0.30	4	6.60 Ea
918	9 1/8" Top OD x 7 7/8" Top ID x 6 7/8" Bottom ID x 1" Deep (23.2 cm x 20 cm x 17.5 cm x 2.5 cm)	24	0.46	12	7.00 Ea
1187	10 1/8" Top OD x 9" Top ID x 8 1/8" Bottom ID x 3/4" Deep (25.7 cm x 22.8 cm x 20.6 cm x 1.9 cm)	24	0.67	18	7.40 Ea
1300	13 1/8" Top OD x 11 1/8" Top ID x 10 3/4" Bottom ID x 7/8" Deep (33.3 cm x 30.2 cm x 27.3 cm x 2.2 cm)	12	0.92	20	10.50 Ea
1600	16 1/8" Top OD x 15" Top ID x 13 3/4" Bottom ID x 7/8" Deep (40.9 cm x 38.1 cm x 34.9 cm x 2.2 cm)	12	1.50	30	13.00 Ea

F) Deep Dish Aluminum Pie Pans

Item No.	Description	Pack	Cu. Ft.	Wt.	List Price
801	8" Top OD x 7 1/8" Top ID x 5 1/2" Bottom ID x 1 1/8" Deep (20.3 cm x 18.1 cm x 14 cm x 2.8 cm)	24	0.30	9	7.20 Ea
897	9" Top OD x 8" Top ID x 6 1/4" Bottom ID x 1 3/8" Deep (22.9 cm x 20.3 cm x 15.9 cm x 3 cm)	24	0.30	12	7.80 Ea
989	9 3/8" Top OD x 9" Top ID x 7" Bottom ID x 1 1/4" Deep (25 cm x 22.8 cm x 17.8 cm x 4.4 cm)	24	0.59	12	10.60 Ea
1188	10 1/8" Top OD x 9" Top ID x 6 3/4" Bottom ID x 1 1/4" Deep (25.7 cm x 22.8 cm x 17.1 cm x 3.2 cm)	12	0.67	13	9.80 Ea
1190	10 7/8" Top OD x 10" Top ID x 8 1/4" Bottom ID x 1 5/8" Deep (27.6 cm x 25.4 cm x 21 cm x 3.3 cm)	12	0.67	14	8.40 Ea
1200	12 1/4" Top OD x 10 7/8" Top ID x 9 1/8" Bottom ID x 1 1/4" Deep (31.1 cm x 27.6 cm x 23.2 cm x 3.2 cm)	12	0.92	15	9.80 Ea

C

A80012



D

3814



E

Pie Pans also make great serving plates!



F



A



HPP16

A



HPP7

B

NEW



4406

4407

A) Heart-Shaped Aluminum Pizza Pans



Feel the love with these special pie pans. Brownies, cakes, and over-sized cookies bake pretty well in here, too!

Item No.	Description	Pack	Cu. Ft.	Wt.	List Price
HPP7	7" W x 1½" Deep (17.8 x 3.8 cm)	24	1.93	13	16.00 Ea
HPP16	16" W x 1½" Deep (40.6 x 3.8 cm)	12	3.68	23	32.00 Ea

B) 6 oz. Glass Contemporary Shakers

A simply designed glass body pairs with cool lids for a contemporary look in these 6 oz. capacity shakers. 2¾" Dia. x 5" H.

Item No.	Description	Pack	Cu. Ft.	Wt.	List Price
4406	Shaker with Cheese Top	12/48	2.16	39	15.00 Ea
4407	Shaker with Spice Top	12/48	2.16	39	15.00 Ea
GLA600	Shaker base only	12/48	2.16	37	12.00 Ea

Replacement Lids

Item No.	Description	Pack	Cu. Ft.	Wt.	List Price
4406T	Cheese	12/288	1.97	25	4.00 Ea
4407T	Spice	12/288	1.97	25	4.00 Ea

C) Mini Stainless Steel Number Tents

Made of dishwasher-safe, high-heat stainless steel, these 1" square, double-sided embossed number tents are perfect for quick serve applications. They make delivering orders as easy as pie!

Item No.	Description	Pack	Cu. Ft.	Wt.	List Price
EM125	Nos. 1 - 25	48	0.42	32	49.00 Set
EM150	Nos. 1 - 50	24	0.34	30	96.00 Set
EM199	Nos. 1 - 99	15	0.16	40	180.00 Set

C



EM199

C

NEW



EM199

D



E



F



D) 8 oz. Glass Shakers

Ideal for cheese and condiments such as red pepper, oregano, etc. 8 oz. (236.6 mL) cap. 2 3/4" Dia. x 3 3/8" H (7 cm x 9.8 cm).

Item No.	Description	Pack	Cu. Ft.	Wt.	List Price
3308	Shaker with Cheese Top	12	0.42	6	3.00 Ea
3309	Shaker with Spice Top	12	0.42	6	3.00 Ea

E) 6 oz. Glass or Lexan Swirl Jar Shakers

6 oz. (177.4 mL) capacity, 2 5/8" Dia. x 3 1/2" H (6.7 x 8.9 cm).

Item No.	Description	Pack	Cu. Ft.	Wt.	List Price
3306	Glass Shaker with Cheese Top	36	0.84	13	1.40 Ea
3307	Glass Shaker with Spice Top	36	0.75	13	1.40 Ea
LX306	Lexan Shaker with Cheese Top*	24/144	3.50	3	2.60 Ea
LX307	Lexan Shaker with Spice Top*	24/144	3.50	3	2.60 Ea

*Not pictured.

F) Stainless Steel Shakers

In cool brushed stainless steel, these shakers feature fine and coarse holes.

Item No.	Description	Pack	Cu. Ft.	Wt.	List Price
TSF7	16 oz. (473.2 mL) 3" Dia x 7" H (7.6 x 17.8 cm) Fine Holes	12/24	1.37	8	21.80 Ea
TSC7	16 oz. (473.2 mL) 3" Dia x 7" H (7.6 x 17.8 cm) Coarse Holes	12/24	1.37	8	21.80 Ea

G) Mini Glass Shakers and Caddy

Easy-to-carry, this stainless steel rack and glass shakers are a fraction of the size of regular shakers.

Item No.	Description	Pack	Cu. Ft.	Wt.	List Price
MGLCS	Set (Includes Caddy and Cheese and Spice Shakers)	36	1.88	29	7.20 Set
MGLA3	2 oz. (59.1 mL) Jar 1 5/8" Dia. x 3 3/8" H (4.1 x 9.2 cm)	24/96	0.71	26	1.60 Ea
MCADDY	4 1/2" L x 2 1/4" W x 5 1/2" H Caddy (11.4 x 5.7 x 14 cm)	36	1.88	12	3.00 Ea

Replacement Mini Lids

Item No.	Description	Pack	Cu. Ft.	Wt.	List Price
M30SP	Salt and Pepper	12/720	0.72	6	0.64 Ea
M312T	Cheese	12/720	0.72	6	0.64 Ea
M316T	Sugar Top Flap	12/720	0.72	6	0.64 Ea
M317T	Spice	12/720	0.72	6	0.64 Ea

G



G



A



FOREVER LIDS

Made in the USA

Manufactured from FDA-approved BPA-free food-grade polypropylene, these plastic tops won't rust, dent or corrode. Available in lots of colors, too!

A) Forever Lids Shaker Tops



12 oz. Perforated

Item No.	Description	Pack	Cu. Ft.	Wt.	List Price
441W	White	12/360	2.37	18	1.82 Ea
442R	Red	12/360	2.37	18	1.82 Ea
443G	Green	12/360	2.37	18	1.82 Ea
444B	Black	12/360	2.37	18	1.82 Ea

6 & 8 oz. Perforated

Item No.	Description	Pack	Cu. Ft.	Wt.	List Price
241W	White	12/600	1.46	14	1.14 Ea
242R	Red	12/600	1.46	14	1.14 Ea
243G	Green	12/600	1.46	14	1.14 Ea
244B	Black	12/600	1.46	14	1.14 Ea
250BLU	Blue	12/600	1.46	14	1.14 Ea
255M	Burgundy	12/600	1.46	14	1.14 Ea
260GR	Gray	12/600	1.46	14	1.14 Ea
260Y	Yellow	12/600	1.46	14	1.14 Ea
2750R	Orange	12/600	1.46	14	1.14 Ea

6 & 8 oz. Slotted

Item No.	Description	Pack	Cu. Ft.	Wt.	List Price
341WSLT	White	12/600	1.46	14	1.14 Ea
342RSLT	Red	12/600	1.46	14	1.14 Ea
343GSLT	Green	12/600	1.46	14	1.14 Ea
344BSLT	Black	12/600	1.46	14	1.14 Ea

A



B & C

Now you can order complete Shaker Sets!



A



B) 2 oz. Glass Salt & Pepper Shakers

Complete sets can now be ordered with shaker base and black or white tops.

Item No.	Description	Pack	Cu. Ft.	Wt.	List Price
PNWP	Shaker with White Top	12	0.21	3	1.90 Ea
PNBP	Shaker with Black Top	12	0.21	3	1.90 Ea
PNSBASE	Shaker Base Only	12/72	0.97	20	1.30 Ea

C) 2 oz. Salt & Pepper Tops



FDA approved polypropylene black and white shaker tops are dishwasher safe, won't stain or fade.

Item No.	Description	Pack	Cu. Ft.	Wt.	List Price
724W	White	12/960	1.46	11	.62 Ea
734B	Black	12/960	1.46	11	.62 Ea

D) 6 oz. Shakers with Slotted Forever Lids

Now you can order complete shaker sets that include the shaker base with a lid in your choice of four colors.

Glass Shakers

Item No.	Description	Pack	Cu. Ft.	Wt.	List Price
33RSL	Shaker with Red Lid	12	0.67	5	1.60 Ea
33GSL	Shaker with Green Lid	12	0.67	5	1.60 Ea
33WSL	Shaker with White Lid	12	0.67	5	1.60 Ea
33BSL	Shaker with Black Lid	12	0.67	5	1.60 Ea
33BASE	Shaker Base Only	12/36	1.75	14	.80 Ea

Lexan Shakers

Item No.	Description	Pack	Cu. Ft.	Wt.	List Price
LXRSL	Shaker with Red Lid	12	0.67	2	2.50 Ea
LXGSL	Shaker with Green Lid	12	0.67	2	2.50 Ea
LXWSL	Shaker with White Lid	12	0.67	2	2.50 Ea
LXBSL	Shaker with Black Lid	12	0.67	2	2.50 Ea
LXBASE	Shaker Base Only	24/144	3.50	18	1.40 Ea

E) 6 oz. Shakers with Perforated Forever Lids

Glass Shakers

Item No.	Description	Pack	Cu. Ft.	Wt.	List Price
33RP	Shaker with Red Lid	12	0.67	5	1.60 Ea
33GP	Shaker with Green Lid	12	0.67	5	1.60 Ea
33WP	Shaker with White Lid	12	0.67	5	1.60 Ea
33BBP	Shaker with Black Lid	12	0.67	5	1.60 Ea
33BASE	Shaker Base Only	12/36	1.75	14	.80 Ea

Lexan Shakers

Item No.	Description	Pack	Cu. Ft.	Wt.	List Price
LXRP	Shaker with Red Lid	12	0.67	2	2.50 Ea
LXGP	Shaker with Green Lid	12	0.67	2	2.50 Ea
LXWP	Shaker with White Lid	12	0.67	2	2.50 Ea
LXBP	Shaker with Black Lid	12	0.67	2	2.50 Ea
LXBASE	Shaker Base Only	24/144	3.50	18	1.40 Ea

F) 12 oz. Shakers with Perforated Forever Lids

Glass Shakers

Item No.	Description	Pack	Cu. Ft.	Wt.	List Price
GLRP	Shaker with Red Lid	12	1.19	10	2.50 Ea
GLGP	Shaker with Green Lid	12	1.19	10	2.50 Ea
GLWP	Shaker with White Lid	12	1.19	10	2.50 Ea
GLBP	Shaker with Black Lid	12	1.19	10	2.50 Ea
GLA300	Shaker Base Only	12/24	1.20	18	1.70 Ea

SAN Shakers

Item No.	Description	Pack	Cu. Ft.	Wt.	List Price
SARP	Shaker with Red Lid	12	1.19	3	3.60 Ea
SAGP	Shaker with Green Lid	12	1.19	3	3.60 Ea
SAWP	Shaker with White Lid	12	1.19	3	3.60 Ea
SABP	Shaker with Black Lid	12	1.19	3	3.60 Ea
SAN300	Shaker Base Only	36	1.44	8	2.20 Ea

D



E



F



A

GLA316
SAN316

GLA312
SAN312



GLA319
SAN319

GLA317
SAN317

GLA318
SAN318

B



3317

3319

3318

3316

3312

C



BEE312

BEE317

BEE319

BEE318

BEE316

D



BEE607

BEE606

E



3316T

3317T

3319T

3307T

3312T

3306T

3318T

A) 12 oz. Shakers

The 12 oz. (354.9 mL) capacity shakers have standard straight-sided fluted shape, are stain-proof, and dishwasher-safe. The SAN plastic shakers are nearly indestructible. Sugar top has a self closing side flap. Each measures 4" Dia. x 5 5/8" H (10.2 x 14.3 cm).

Glass

Item No.	Description	Pack	Cu. Ft.	Wt.	List Price
GLA312	Shaker w/Cheese Top	12	1.19	10	2.10 Ea
GLA316	Shaker w/Sugar Top	12	1.19	10	2.10 Ea
GLA317	Shaker w/Spice Top	12	1.19	10	2.10 Ea
GLA318	Shaker w/Dredge Top	12	1.19	10	2.10 Ea
GLA319	Shaker w/Extra Large 1/4" Holes Cheese Top	12	1.19	10	2.10 Ea
GLA300	Extra jar	12/24	1.20	18	1.70 Ea

SAN Plastic

Item No.	Description	Pack	Cu. Ft.	Wt.	List Price
SAN312	Shaker w/Cheese Top	12	1.19	3	2.80 Ea
SAN316	Shaker w/Sugar Top	12	1.19	3	2.80 Ea
SAN317	Shaker w/Spice Top	12	1.19	3	2.80 Ea
SAN318	Shaker w/Dredge Top	12	1.19	3	3.10 Ea
SAN319	Shaker w/Extra Large 1/4" Holes Cheese Top	12	1.19	3	2.80 Ea
SAN300	Extra jar	36	1.44	8	2.20 Ea

B) 12 oz. Plastic Shakers

Heavy-duty SAN plastic bases with stainless tops. Odorless and dishwasher-safe. Tapered bases nest (without tops) for easy storage. Each measures 3 5/8" Dia. x 5 1/2" H (8.6 x 14 cm). Capacity 12 oz. (354.9 mL).

Item No.	Description	Pack	Cu. Ft.	Wt.	List Price
3312	Shaker w/Cheese Top	12	1.19	4	3.00 Ea
3316	Shaker w/Sugar Top	12	1.19	4	3.00 Ea
3317	Shaker w/Spice Top	12	1.19	4	3.00 Ea
3318	Shaker w/Dredge Top	12	1.19	4	3.50 Ea
3319	Shaker w/Extra Large 1/4" Holes Cheese Top	12	1.19	4	3.00 Ea
3300	Shaker jar only	24/72	1.27	13	2.20 Ea

C) 12 oz. Glass Beehive Shakers

These 12 oz. (354.9 mL) Beehive Shakers are creating quite a buzz!

Item No.	Description	Pack	Cu. Ft.	Wt.	List Price
BEE312	Shaker w/Cheese Top	12	1.19	10	2.30 Ea
BEE316	Shaker w/Sugar Top	12	1.19	10	2.30 Ea
BEE317	Shaker w/Spice Top	12	1.19	10	2.30 Ea
BEE318	Shaker w/Dredge Top	12	1.19	10	2.30 Ea
BEE319	Shaker w/Extra Large Holes Cheese Top	12	1.19	10	2.30 Ea
BEE300	Shaker base only	24	0.80	20	1.90 Ea

D) 6 oz. Glass Beehive Shakers

Ridged glass design looks great on its own or paired with other accessories from this line.

Item No.	Description	Pack	Cu. Ft.	Wt.	List Price
BEE606	6 oz. (177.4 mL) Shaker w/Cheese Top	12	0.67	5	1.50 Ea
BEE607	6 oz. (177.4 mL) Shaker w/Spice Top	12	0.67	5	1.50 Ea
BEE600	6 oz. (177.4 mL) Shaker base only	36	0.80	11	1.20 Ea

E) Shaker Tops

In seven quality stainless steel designs.

6 & 8 oz. Tops

Item No.	Description	Pack	Cu. Ft.	Wt.	List Price
3307T	Spice slotted	12/720	1.56	20	.68 Ea
3306T	Cheese round	12/720	1.56	21	.68 Ea

12 oz. Tops 3" Dia. x 3/4" H (7.6 x 1.9 cm)

Item No.	Description	Pack	Cu. Ft.	Wt.	List Price
3312T	Cheese with large round holes	12/720	2.10	33	.90 Ea
3316T	Sugar top flap	12/720	2.66	34	.90 Ea
3317T	Spice slotted	12/720	2.51	34	.90 Ea
3318T	Dredge with small round holes	12/720	2.51	34	1.14 Ea
3319T	Cheese shaker with extra large holes (1/4" hole)	12/720	2.64	27	.90 Ea



F

DRCKC7

DRCKC6 shown with
2212 wood peel and
MGLCS mini glass
shakers and caddy



F

DRCKB7

DRCKB6

shown with FSLT14 faux slate
platter, HMMJ4 mini apothecary jar,
PSDH22 sauce cup and PSMS mustard spade



G

PPRW1616

PPRN1616

PPCH4N

F) Square and Rectangular Stands

Item No.	Description	Pack	Cu. Ft.	Wt.	List Price
DRCKC7	Stainless Steel Square 7" Sq. Top x 9" Sq. Bottom x 7" H (17.8 x 22.9 x 17.8 cm)	24	3.55	19	19.00 Ea
DRCKC6	Stainless Steel Rectangle 9" L x 6" W Top x 11" L x 8" W Bottom x 7" H (22.9 x 15.2 x 27.9 x 20.3 x 17.8 cm)	24	2.01	18	20.00 Ea
DRCKB7	Black Square 7" Sq. Top x 9" Sq. Bottom x 7" H (17.8 x 22.9 x 17.8 cm)	24	3.55	19	19.00 Ea
DRCKB6	Black Rectangle 9" L x 6" W Top x 11" L x 8" W Bottom x 7" H (22.9 x 15.2 x 27.9 x 20.3 x 17.8 cm)	24	2.01	18	20.00 Ea

G) Square Paper

Now in a larger 16" (40.6 cm) size! Perfect for serving pizza! 1000 per pack.

Item No.	Description	Pack	Cu. Ft.	Wt.	List Price
PPRW1616	White	3	1.10	39	134.00 Pk
PPCH4N	Natural	3	1.10	39	144.00 Pk
PPRN1616	Newspaper	3	1.10	39	160.00 Pk

H) Stainless Steel Pizza Stands

Item No.	Description	Pack	Cu. Ft.	Wt.	List Price
SDRCK4	7½" Top Dia. x 9½" Bottom Dia. x 4" H (19.1 x 24.4 x 10.2 cm)	12/36	3.58	19	6.40 Ea
SDRCK	7½" Top Dia. x 9½" Bottom Dia. x 7¾" H (19.1 x 24.4 x 18.7 cm)	12/36	4.81	23	7.80 Ea

I) Universal Stands

Item No.	Description	Pack	Cu. Ft.	Wt.	List Price
BUS309	Black 9" L x 8" W x 7" H (22.9 x 20.3 x 17.8 cm)	24	0.93	25	7.30 Ea
BUS312	Black 12" L x 12" W x 7" H (30.5 x 30.5 x 17.8 cm)	12/24	1.49	32	11.60 Ea
190039	Chrome-Plated 9" L x 8" W x 7" H (22.9 x 20.3 x 17.8 cm)	24	0.98	28	7.30 Ea
1900312	Chrome-Plated 12" L x 12" W x 7" H (30.5 x 30.5 x 17.8 cm)	12/24	3.31	47	11.60 Ea

Slip Stop Sleeves

Black plastic sleeves keep pizza trays and plates from sliding on stand. Also prevents stand from sliding on table.

Item No.	Description	Pack	Cu. Ft.	Wt.	List Price
3SSS	3 Pieces 4" L x ¼" ID x ¼" Thick (10.2 x .64 x .16 cm) Fits 190039, 1900312, BUS309, BUS312, LWUS779, SSUS1	240	0.78	12	2.00 Set
4SSS	4 Pieces 4½" L x ¼" ID x ¼" Thick (10.5 x .64 x .16 cm) Fits PSS77, DPS797	240	0.83	13	2.00 Set



H

SDRCK with TP14
tray and BEE312 and
BEE317 shakers

SDRCK4 with TP14 tray
and MGLA3 shakers



I

Shown with 3218 wood
peel and BEE319 shaker

BUS309

BUS312



I

190039 with HC90162 pan
(Slip stop sleeves sold
separately)

A



DPS797 with TP14 pan

PSS77 with A90162 pan

A) Contempo™ Pizza Stands



Creatively crafted in a drum or scroll design, they are perfect for use together in a pizza buffet or as stand alone units.

Item No.	Description	Pack	Cu. Ft.	Wt.	List Price
DPS797	Drum 7" Top Dia. x 9" Bottom Dia. x 7" H (17.8 x 22.9 x 17.8 cm)	48	4.48	26	10.00 Ea
PSS77	Black Square Scroll 7" Sq. x 9" H (17.8 x 22.9 cm)	6	2.73	13	22.00 Ea

B



LWUS779 with TP12 pan

SSUS1

B) Contempo™ Swirl Pizza Stands



Item No.	Description	Pack	Cu. Ft.	Wt.	List Price
LWUS779	Black Wrought Iron 7" Top Dia. x 9" Bottom Dia. x 7" H (17.8 x 22.9 x 17.8 cm)	6	3.22	12	21.20 Ea
SSUS1	Stainless Steel 7" Top Dia. x 9" Bottom Dia. x 7" H (17.8 x 22.9 x 17.8 cm)	6	1.23	12	39.60 Ea

Slip Stop Sleeves



Black plastic sleeves keep pizza trays and plates from sliding on stand. Also prevents stand from sliding on table.

Item No.	Description	Pack	Cu. Ft.	Wt.	List Price
3SSS	3 Pieces 4" L x 1/4" ID x 1/16" Thick (10.2 x .64 x .16 cm) Fits 190039, 1900312, BUS309, BUS312, LWUS779, SSUS1	240	0.78	12	2.00 Set
4SSS	4 Pieces 4 1/8" L x 1/4" ID x 1/16" Thick (10.5 x .64 x .16 cm) Fits PSS77, DPS797	240	0.83	13	2.00 Set

C



CERAM18

CERAM16

CERAM12 on LWUS779 stand

C) Ceramic Pizza Trays

These ceramic trays add an old-world touch to pizza presentations. Available in four sizes, they fit most standard sized pizzas.

Item No.	Description	Pack	Cu. Ft.	Wt.	List Price
CERAM12	12" Dia. (30.5 cm)	6	0.97	18	13.80 Ea
CERAM14	14" Dia. (35.6 cm)	4	1.01	16	27.60 Ea
CERAM16	16" Dia. (40.6 cm)	1	0.88	7	40.20 Ea
CERAM18	18" Dia. (45.7 cm)	1	1.07	8	58.20 Ea

D



TLSP1219 with TP15 pan

E



TLTS1224

Save on table space

D) Black Iron Pizza Stand



Serve twice the pizza without taking up valuable table space with this two-tier stand from our Ironworks Collection.

Item No.	Description	Pack	Cu. Ft.	Wt.	List Price
TLSP1219	19 $\frac{5}{8}$ " L x 11 $\frac{3}{4}$ " W x 12 $\frac{3}{4}$ " H (49.2 x 29.9 x 31.4 cm)	2	1.9	8	47.00 Ea

E) Twisted Pizza Stand



Twisted wrought iron black stand features handles on opposite sides for easy transport. Some assembly required.

Item No.	Description	Pack	Cu. Ft.	Wt.	List Price
TLTS1224	24" L x 13 $\frac{3}{8}$ " W x 12 $\frac{1}{4}$ " H (61 x 35.2 x 31.1 cm)	6	2.12	39	51.80 Ea

F



PSTRN14

SW12PAS

PSCS13

F) Deluxe Stainless Steel Pizza Servers

Item No.	Description	Pack	Cu. Ft.	Wt.	List Price
SW12PAS	11" L (27.9 cm) Server	12/144	1.06	43	13.00 Ea
PSTRN14	13 $\frac{3}{8}$ " L (34 cm) Server/ Turner	6/48	1.64	14	17.60 Ea
PSCS13	13 $\frac{1}{2}$ " L (34.3 cm) Server	6/48	1.64	14	22.60 Ea

G) Pizza Servers and Turner

Item No.	Description	Pack	Cu. Ft.	Wt.	List Price
19006	Stainless Steel Pizza Server with Wood Handle 5" L x 2 $\frac{1}{2}$ " x 1 $\frac{1}{2}$ " Blade, 10 $\frac{1}{2}$ " L Overall (12.7 x 6.3 x 3.8 cm Blade, 26.7 cm Overall)	12/120	1.28	24	2.60 Ea
PS10	Stainless Steel Turner with Plastic Handle 3 $\frac{3}{8}$ " L x 1 $\frac{1}{8}$ " W Blade, 10" Overall (9.2 x 4.8 cm Blade, 25.4 cm Overall)	12/120	0.91	30	4.20 Ea
PS196	Stainless Steel Pizza Server with Dark Brown Handle 5" L x 2 $\frac{1}{2}$ " x 1 $\frac{1}{2}$ " Blade, 10 $\frac{1}{2}$ " L Overall (12.7 x 6.3 x 3.8 x 26.7 cm)	12/120	1.53	34	4.50 Ea

G



19006

PS196

PS10

A



B



C



A) Plastic Handle Pizza Cutters

Heavy-duty one-piece molded plastic handles, stainless steel wheels.

Item No.	Description	Pack	Cu. Ft.	Wt.	List Price
PPC2	2¾" Dia. (7 cm) Wheel w/Black Handle	12/144	2.26	50	7.50 Ea
PCW2	Blade for PPC2	12/240	0.68	36	5.00 Ea
PPC4	4" Dia. (10.2 cm) Wheel w/Black Handle	12/72	1.38	31	9.00 Ea
PIZW1	4" Dia. (10.2 cm) Wheel w/White Handle	12/72	1.34	31	10.60 Ea
PIZR2	4" Dia. (10.2 cm) Wheel w/Red Handle	12/72	1.34	31	10.60 Ea
PIZG3	4" Dia. (10.2 cm) Wheel w/Green Handle	12/72	1.34	31	10.60 Ea
PCW4	Blade for PPC4, PIZW1, PIZR2, PIZG3	12/300	0.83	42	5.60 Ea
PPC5	5" Dia. (12.7 cm) Wheel w/Black Handle	12/72	1.63	39	10.80 Ea
PCW5	Blade for PPC5	12/240	1.35	60	7.00 Ea
PPCHARDWARE	Axle Assembly, w/Screw Bushing and Lock Nut	60/1200	0.22	25	3.20 Ea

B) Aluminum Handle Pizza Cutter

Heavy cast aluminum handle with a stainless steel wheel.

Item No.	Description	Pack	Cu. Ft.	Wt.	List Price
APC2	2¾" Dia. (6.7 cm) Blade	24/72	1.25	31	8.20 Ea

C) Wood Handle Pizza Cutters

Sanitary, stainless steel cutting wheels, rust proof guards, wooden handles. Quality tool needed for pizza serving, can be used as a pastry wheel.

Item No.	Description	Pack	Cu. Ft.	Wt.	List Price
PC7250	2½" Dia. (6.3 cm) Wheel	12/144	1.31	25	5.80 Ea
PC7400	4" Dia. (10.2 cm) Wheel	12/72	1.29	29	9.40 Ea

D) Pressed Wood Pizza Rocker Knives

Made of NSF and USDA material, these pressed wood rockers provide a durable and clean cutting edge.

Item No.	Description	Pack	Cu. Ft.	Wt.	List Price
PRKS	10" L x 5¼" W (25.4 x 13.3 cm)	12	0.15	7	37.00 Ea
PRKL	20" L x 5¼" W (50.8 x 13.3 cm)	12	0.30	13	57.00 Ea

E) Pizza Knives

American Metalcraft has a pizza knife for everyone. These full-tang knives feature stainless steel blades and double handles for safer use.

Item No.	Description	Pack	Cu. Ft.	Wt.	List Price
PPK17	18" L (45.7 cm) Blade POM Handle	6	0.45	9	42.00 Ea
 PWK19	18" L (45.7 cm) Blade Wood Handle	6	0.30	9	42.00 Ea

F) Pizza Rocker Knives

Perfect for chopping, cutting, etc. Stainless steel blades. Full rocker designs.

Item No.	Description	Pack	Cu. Ft.	Wt.	List Price
PRS14	14" H (35.6 cm)	6/36	2.41	26	12.00 Ea
PRS22	22" H (55.9 cm)	6/24	2.83	31	23.00 Ea
PKR20	20" L x 4¾" H Blade 21½" L Overall Black Handle (50.8 x 12.1 x 54.6 cm)	24	1.36	45	71.00 Ea

G) Multi-Wheel Pastry Cutter

Six 2" parallel wheels. Size: 2½" x 9½" tall closed, 24½" x 9½" tall open. Wheels adjust from ¼" to 4¾" between wheels.

Item No.	Description	Pack	Cu. Ft.	Wt.	List Price
MWPC6X2	Multi-Wheel Cutter	36	2.16	50	40.00 Ea

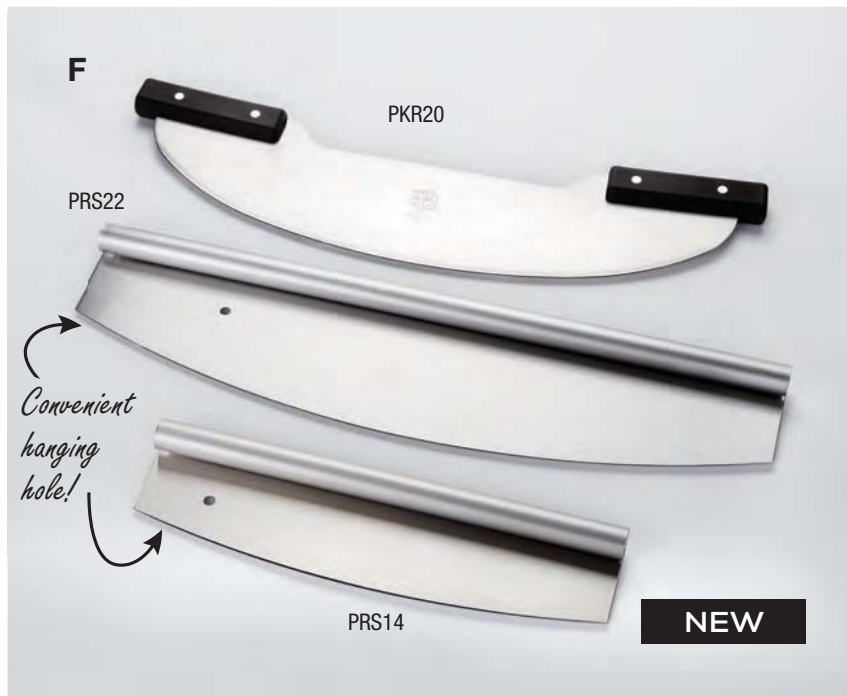
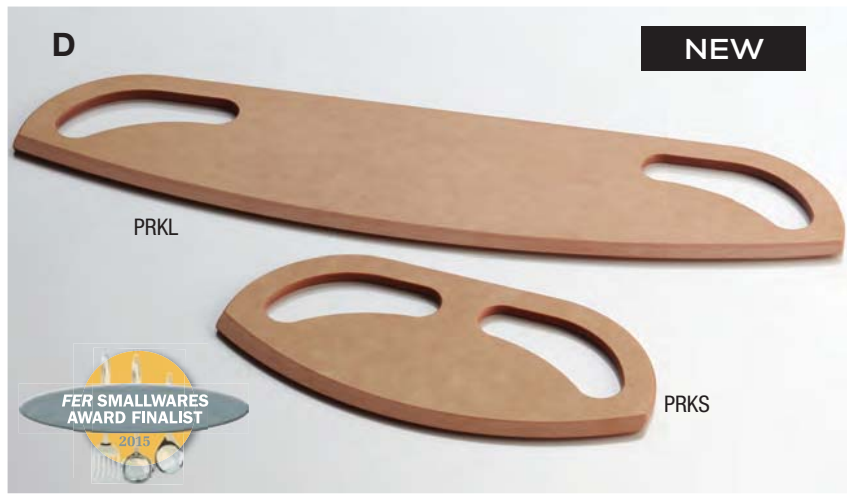



A) Deluxe Pizza Stones

Perfect for small restaurants and bars. Ideal where hearth baking is not possible. Keeps pizzas warm in heated display cases. Made of Cordierite; a no lead fire brick material. FDA-approved for oven use. Perfect thickness and porosity for heat retention.

Item No.	Description	Pack	Cu. Ft.	Wt.	List Price
PS85	8½" Dia. x ½" H (21.6 x 1.3 cm) Round	1	0.40	3	59.00 Ea
PS105	10½" Dia. x ½" H (26.7 x 1.3 cm) Round	1	0.57	4	83.00 Ea
PS1116	16" L x 11" W x ¾" H (40.6 x 27.9 x .95 cm) Rectangle	1	0.65	11	94.00 Ea
PS1416	16" L x 14" W x 7⁄8" H (40.6 x 35.6 x 2.2 cm) Rectangle	6	4.00	72	98.00 Ea
PS1575	15¾" Dia. x 7⁄8" H (40 cm x 2.2 cm) Round	6	4.00	67	98.00 Ea



B) Economy Pizza Stones



Dishwasher-safe, ceramic baking stones. Creates a light, crispy crust by distributing heat evenly and efficiently.

Item No.	Description	Pack	Cu. Ft.	Wt.	List Price
STONE13	13" Dia. x ¾" H (33 x 1 cm) Round	12	1.09	48	14.00 Ea
STONE12	15" L x 12" W x ¾" H (38 x 30.5 x 1 cm) Rectangle	8	0.78	42	17.00 Ea
STONE15	15" Dia. x ¾" H (38 x 1 cm) Round	8	0.83	43	17.60 Ea
STONE14	15" L x 14" W x ¾" H (38 x 35.6 x 1 cm) Rectangle	6	0.71	40	19.80 Ea

*All Stones are
FDA-approved!*





19029 with HCDEP12 and TP12 pans



19030 with ADEP12 and HCDEP12 pans



19033 with HC90182 and HA2018 pans

C) Pizza Racks

Pizza racks have square bases and are made of heavy $\frac{3}{8}$ " (.95 cm) and $\frac{3}{16}$ " (.47 cm) chrome plated steel rod. Shelves can hold up to 6 lbs. (2.72 kg) each. Holds pizza trays, screens, separators, etc. from 10" (25.4 cm) through 23" (58.4 cm) dia. All units stand 27 $\frac{1}{2}$ " (69.85 cm) H.

Item No.	Description	Pack	Cu. Ft.	Wt.	List Price
19029	Standard for Pans up to 1 $\frac{1}{4}$ " (3.18 cm) Deep 10" - 17" (25.4 - 43.2 cm) Dia. 15 Shelves, with 1 $\frac{5}{8}$ " (3.49 cm) between with 12" (30.48 cm) Base	2	2.97	15	64.00 Ea
19030	Standard for Pans up to 2 $\frac{1}{4}$ " (5.08 cm) Deep 10" - 17" (25.4 - 43.2 cm) Dia. 11 Shelves, with 2 $\frac{1}{2}$ " (6.35 cm) between with 12" (30.48 cm) Base	2	2.91	13	60.00 Ea
19024	Standard for Pans up to $\frac{1}{2}$ " (1.2 cm) Deep 10" - 17" (25.4 - 43.2 cm) Dia. 24 Shelves with $\frac{3}{4}$ " (1.9 cm) between with 12" (30.5 cm) Base	2	3.03	19	78.00 Ea
19033	Over Size for Pans up to 2 $\frac{1}{4}$ " (5.08 cm) Deep 16" - 23" (40.6 - 58.4 cm) Dia. 10 Shelves, with 2 $\frac{1}{2}$ " (6.35 cm) between with 16" (40.6 cm) Base	2	4.94	22	80.00 Ea

D) Dough Cutters and Scrapers

Stainless blade and wood or plastic handle.

Item No.	Description	Pack	Cu. Ft.	Wt.	List Price
DS6704	Wood Handle 4 $\frac{1}{2}$ " H (11.4 cm)	12/120	1.45	50	3.80 Ea
DSP6705	Plastic Handle 4 $\frac{1}{2}$ " H (11.4 cm)	12/120	1.33	50	4.90 Ea
DS6706	Wood Handle 6" H (15.2 cm)	120	1.75	50	5.90 Ea

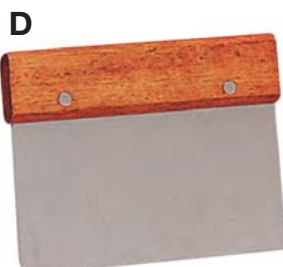

DS6704



DS6706



DSP6705

The rounded corner cleans the Dough Box without excessive scratching

A



B



C



D



E



F



A) Heavy-Duty Plastic Roller Docker

Individual wheels with plastic points spin independently on a stainless axle.

Item No.	Description	Pack	Cu. Ft.	Wt.	List Price
DD5274	Half-Size Plastic Docker 3½" W x 8¾" L (8.9 x 22.2 cm), Plastic Handle	24	2.10	20	17.60 Ea
DD5705	Full Size Plastic Docker 5½" W x 8¾" L (13.9 x 22.2 cm), Aluminum Handle	24	2.11	25	35.00 Ea
DDW5705	Extra Wheels	12	0.30	2	2.00 Ea

B) Ten-Wheel Casted Handle Dough Docker

Heavy-duty cast aluminum handle, ten-piece plastic wheel base. One-piece handle, interchangeable wheels.

Item No.	Description	Pack	Cu. Ft.	Wt.	List Price
DDCH7755	6" W x 7½" L (15.2 x 19.1 cm)	24	2.80	37	34.20 Ea
DDW5705	Extra Wheels	12	0.30	2	2.00 Ea

C) All-Plastic Dough Docker

One-piece plastic core features ⅝" (1.5 cm) long pins. Dishwasher-safe.

Item No.	Description	Pack	Cu. Ft.	Wt.	List Price
DD5701	Plastic Docker	6/72	4.65	31	10.00 Ea

D) Long-Pin Dockers

Unit made with two sets of interlocking plastic pins.

Item No.	Description	Pack	Cu. Ft.	Wt.	List Price
DD5703	Plastic Pin Docker, ⅞" L Pins (2.2 cm) 3½" W x 8½" Overall (8.9 cm x 21.6 cm)	24	2.19	16	15.20 Ea
DDW5703	Extra Wheels	24	2.20	17	1.80 Ea

E) Heavy-Duty Roller Dockers

Professional bakers tools designed for heavy and continuous use. ¼" (.9 cm) stainless steel pins are permanently embedded in a plastic core. Permanent stainless axle and sanitary solid aluminum handle.

Item No.	Description	Pack	Cu. Ft.	Wt.	List Price
DD5275	Half-Size Docker 2¾" W x 1¾" Dia. Barrel (7 x 4.4 cm)	24	1.71	29	28.60 Ea
DD5704	Regular Docker 5" W x 1¾" Dia. Barrel (12.7 x 4.4 cm)	24	2.38	31	33.20 Ea

F) Casted Handle Dough Docker

One-piece cast aluminum handle wears longer than others. ⅜" (.9 cm) stainless steel pins are embedded in plastic roller.

Item No.	Description	Pack	Cu. Ft.	Wt.	List Price
DDCH7744	6" W x 7½" L (15.2 x 19.1 cm)	24	2.70	32	34.20 Ea

G) Pizza Slice Cutting Guide

Boards are marked on one side only. The marking is in food-safe FDA approved inks placed below the surface of the board. NSF and USDA listed material pizza guide cutting boards.

Item No.	Description	Pack	Cu. Ft.	Wt.	List Price
MPCUT4	20" Sq. x ¼" H (50.8 x .6 cm) Board with Markings for 4 Slice or 8 Slice	6	0.94	32	106.00 Ea
MPCUT6	20" Sq. x ¼" H (50.8 x .6 cm) Board with Markings for 6 Slice	6	0.94	32	106.00 Ea

H) Pizza Bubble Poppers

Choose from a variety of bubble poppers including wood handles, all aluminum and our red rubber gripper popper that easily fits into conveyor style pizza ovens.

Item No.	Description	Pack	Cu. Ft.	Wt.	List Price
BP23	23" L (58.4 cm)	12	0.49	6	14.00 Ea
SBP30	30" L (76.2 cm)	72	0.67	35	13.00 Ea
19085	31" L (78.7 cm)	6	0.62	6	13.40 Ea
BP39	39" L (99 cm)	12	0.62	11	18.00 Ea
19009	43" L (109.2 cm)	6	0.69	9	16.00 Ea
BP51	51" L (129.5 cm)	12	0.91	14	27.00 Ea

G

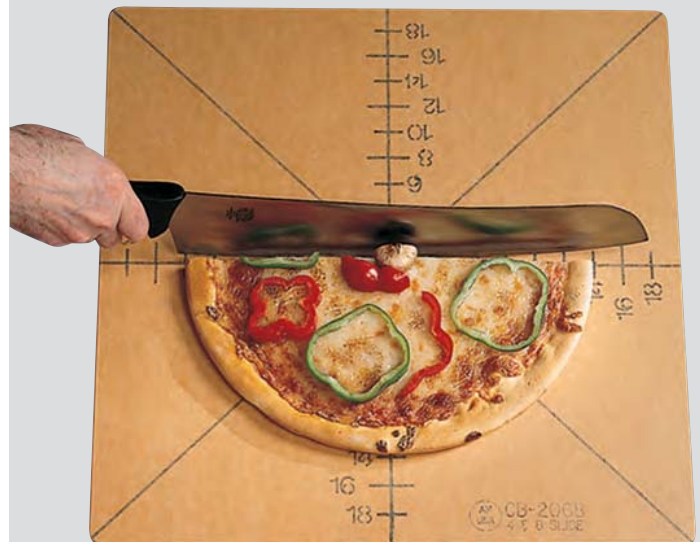

MPCUT4



H



BP23

SBP30

19085
All-Aluminum

BP39

19009
All-Aluminum

BP51

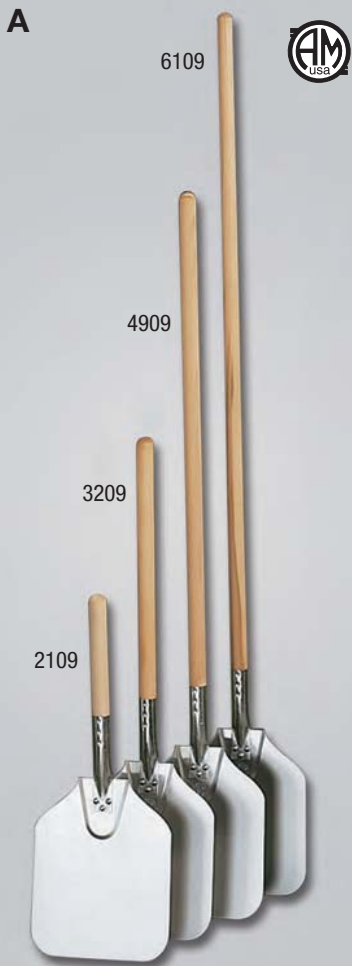

A) Aluminum Small Blade Peels 
9" x 11" (22.9 x 28 cm) Blade

Item No.	Description	Pack	Cu. Ft.	Wt.	List Price
2109	21" L Overall (53.3 cm)	6	0.81	9	16.20 Ea
3209	32½" L Overall (82.6 cm)	12	1.26	18	18.40 Ea
4909	49" L Overall (124.5 cm)	12	1.90	21	23.80 Ea
6109	61" L Overall (155 cm)	12	2.40	25	31.00 Ea

B) Aluminum Medium Blade Peels 
12" x 14" (30.5 x 35.6 cm) Blade

Item No.	Description	Pack	Cu. Ft.	Wt.	List Price
2512	26" L Overall (66 cm)	6	0.81	13	16.80 Ea
3512	35½" L Overall (90.2 cm)	6	1.14	13	18.60 Ea
5212	52" L Overall (132.1 cm)	6	1.47	13	24.40 Ea
6412	64" L Overall (162.6 cm)	8	2.00	20	32.00 Ea

C) Aluminum Large Blade Peels 
14" x 16" (35.6 x 40.6 cm) Blade

Item No.	Description	Pack	Cu. Ft.	Wt.	List Price
2814	28" L Overall (71.1 cm)	8	1.33	13	20.40 Ea
3714	37" L Overall (94 cm)	6	1.41	14	21.60 Ea
5414	54" L Overall (137.2 cm)	8	1.94	20	29.60 Ea
6614	66" L Overall (167.6 cm)	8	2.40	21	37.40 Ea

D) Aluminum Extra Large Blade Peels 
16" x 18" (40.6 x 45.7 cm) Blade

Item No.	Description	Pack	Cu. Ft.	Wt.	List Price
3016	30" L Overall (76.2 cm)	6	1.41	16	23.20 Ea
4016	39½" L Overall (100.3 cm)	6	1.83	18	26.20 Ea
5616	56" L Overall (142.2 cm)	6	2.11	19	33.60 Ea
6816	68" L Overall (172.7 cm)	8	2.92	24	41.60 Ea

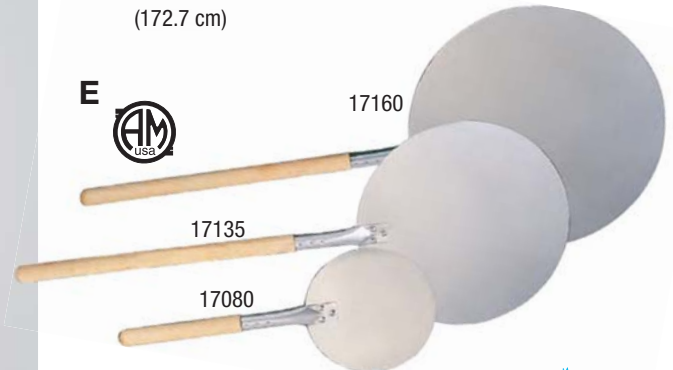
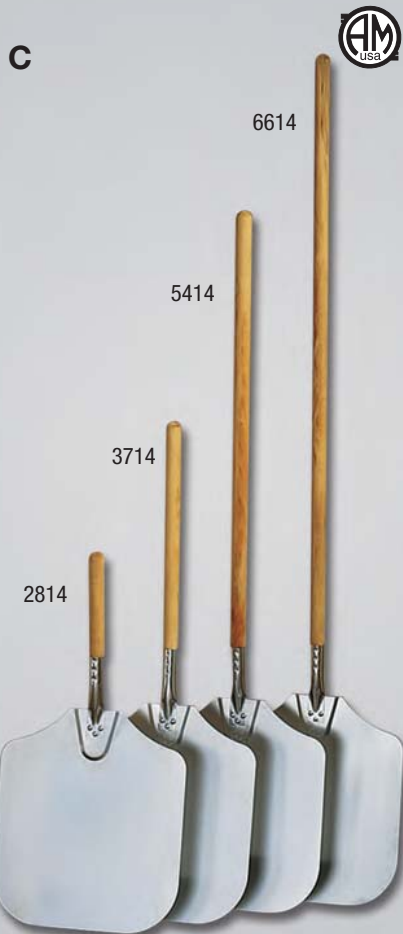

E) Aluminum Round Blade Peels 

Item No.	Description	Pack	Cu. Ft.	Wt.	List Price
17080	20" L Overall (50.8 cm) 8" Dia. (20.3 cm) Blade	6	0.93	8	14.20 Ea
17135	35" L Overall (88.9 cm) 13½" Dia. (34.3 cm) Blade	6	1.30	11	21.00 Ea
17160	38" L Overall (95.3 cm) 16" Dia. (40.6 cm) Blade	6	1.83	14	25.40 Ea

Perf P	Add to List Price	3.60 Ea
---------------	-------------------	----------------

F



F) Small All-Aluminum Peel



Item No.	Description	Pack	Cu. Ft.	Wt.	List Price
674	6¾" x 7¾" Blade, 20½" L (17.1 x 19.7, 52.1 cm)	6	0.09	7	15.00 Ea

G) Small Deluxe All-Aluminum Peels
12" (30.5 cm) Square Blade



Item No.	Description	Wt.	List Price
ITP1213	27" (68.6 cm) Overall	13 Lb/Dz	51.40 Ea
ITP1222	37" (94 cm) Overall	15 Lb/Dz	53.60 Ea
ITP1238	52" (132.1 cm) Overall	19 Lb/Dz	56.80 Ea
ITP1246	60" (152.4 cm) Overall	21 Lb/Dz	59.20 Ea

H) Medium Deluxe All-Aluminum Peels
14½" (36.8 cm) Square Blade



Item No.	Description	Wt.	List Price
ITP1413	30" (76.2 cm) Overall	16 Lb/Dz	61.00 Ea
ITP1422	39" (99.1 cm) Overall	18 Lb/Dz	64.00 Ea
ITP1438	55½" (141 cm) Overall	21 Lb/Dz	66.40 Ea
ITP1446	63½" (161.3 cm) Overall	23 Lb/Dz	69.00 Ea

I) Large Deluxe All-Aluminum Peels
17½" x 18½" (44.5 x 47 cm) Blade



Item No.	Description	Wt.	List Price
ITP1713	34" (86.4 cm) Overall	29 Lb/Dz	79.40 Ea
ITP1722	43" (109.2 cm) Overall	32 Lb/Dz	82.00 Ea
ITP1738	59½" (151.1 cm) Overall	35 Lb/Dz	85.00 Ea
ITP1746	68" (172.7 cm) Overall	36 Lb/Dz	87.00 Ea

J) Extra Large Deluxe All-Aluminum Peels
19½" x 21" (49.5 x 53.3 cm) Blade



Item No.	Description	Wt.	List Price
ITP1913	37" (94 cm) Overall	36 Lb/Dz	90.00 Ea
ITP1922	45½" (115.6 cm) Overall	38 Lb/Dz	93.00 Ea
ITP1938	62" (157.5 cm) Overall	41 Lb/Dz	96.60 Ea
ITP1946	67¾" (172.1 cm) Overall	43 Lb/Dz	98.80 Ea

K) Chrome on Steel Peel Rack



Item No.	Description	Pack	Cu. Ft.	Wt.	List Price
WPH45153	4⅝" W x 1¼" D x 3" H (11.7 x 3.2 x 7.6 cm)	120	1.07	46	12.00 Ea

G

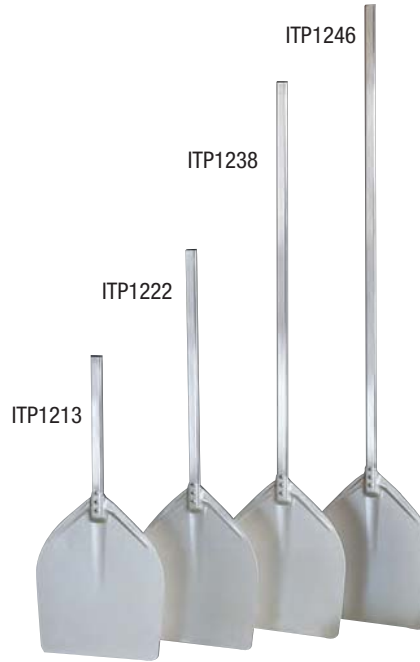

H



I



J



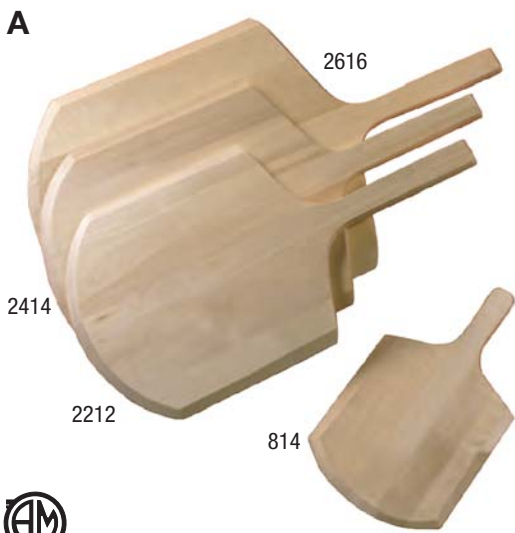

Wood Peels and Boards should be wiped with a damp cloth. Never soak with water!



Pizza Peel Wood Oil



Wood pizza peels should never be used under heat lamps or soaked in water. If necessary they can be seasoned or sealed with oil. To seal, wipe any food safe oil (like mineral oil) on the surface of the peel. Some oils will eventually go rancid; these oils should be avoided. If sealed, the peel is less likely to pick up unwanted odors, food particles and moisture. This will not increase the life span of the peel. Peels eventually wear out. If peel warps, leave overnight with the warp facing up and it should flatten out. Avoid leaving on hot surfaces, which could increase chance of warping. Pizza peels are not dishwasher-safe.



Item No.	Description	Pack	Cu. Ft.	Wt.	List Price
WDOIL	8 oz. (236.6 mL)	12	0.27	9	12.40 Ea

Wood Peels

A) Standard Blade Short Handle

Item No.	Description	Pack	Cu. Ft.	Wt.	List Price
814	8" W x 9" L Blade, 14" L Overall (20.3 x 22.9 x 12.7 x 35.6 cm)	50	0.95	16	19.20 Ea
2212	12" W x 13" L Blade, 22" L Overall (30.5 x 33 x 22.9 x 55.9 cm)	6	0.70	9	30.20 Ea
2414	14" W x 15" L Blade, 24" L Overall (35.6 x 38.1 x 22.9 x 60.1 cm)	6	0.91	12	33.80 Ea
2616	16" W x 17" L Blade, 26" L Overall (40.6 x 43.2 x 22.9 x 66 cm)	6	1.11	15	40.60 Ea

B) Square Blade – 39" L (99.1 cm) Overall

Item No.	Description	Pack	Cu. Ft.	Wt.	List Price
1139	11" Sq. (27.9 cm) Blade	6	1.30	9	35.20 Ea

C) Make-Up Peel – 32" L (81.3 cm) Overall

Item No.	Description	Pack	Cu. Ft.	Wt.	List Price
3218	18" W x 17½" L Blade (45.7 x 44.5 x 81.3 cm)	6	1.61	19	52.40 Ea

D) Standard Blade – 36" L (91.4 cm) Handle

Item No.	Description	Pack	Cu. Ft.	Wt.	List Price
3612	12" W x 13" L Blade (30.5 x 33 cm)	6	1.49	9	38.40 Ea
3614	14" W x 15" L Blade (35.6 x 38.1 cm)	6	1.39	12	42.00 Ea
3616	16" W x 17" L Blade (40.6 x 43.2 cm)	6	1.46	14	48.00 Ea

E) Standard Blade – 42" L (106.7 cm) Overall

Item No.	Description	Pack	Cu. Ft.	Wt.	List Price
4212	12" W x 13" L Blade (30.5 x 33 cm)	6	1.17	10	41.00 Ea
4214	14" W x 15" L Blade (35.6 x 38.1 cm)	6	1.39	12	45.40 Ea
4216	16" W x 17" L Blade (40.6 x 43.2 cm)	6	1.59	16	51.80 Ea
4218	18" W x 18" L Blade (45.7 x 45.7 cm)	6	1.79	19	58.40 Ea
4220	20" W x 21" L Blade (50.8 x 53.3 cm)	6	1.99	24	65.00 Ea

F) Long Blade – 6½" L (16.5 cm) Handle

Item No.	Description	Pack	Cu. Ft.	Wt.	List Price
836	8" W x 29½" L Blade, 36" L Overall (20.3 x 74.9 x 91.4 cm)	6	0.77	15	37.60 Ea
1636	16" W x 29½" L Blade, 36" L Overall (40.6 x 74.9 x 91.4 cm)	6	1.46	29	57.40 Ea
1836	18" W x 29½" L Blade, 36" L Overall (45.7 x 74.9 x 91.4 cm)	6	1.63	34	74.00 Ea
1842	18" W x 36" L Blade, 42" L Overall (45.7 x 91.4 x 107 cm)	3	1.42	27	79.20 Ea
2242	22" W x 36" L Blade, 42" L Overall (55.9 x 91.4 x 107 cm)	3	1.72	31	106.00 Ea

Pressed Peels

Pressed Peels are made of NSF and USDA listed material. Should overcome all objections health departments have with traditional wood peels and boards.

G) Round Pressed Pizza Peels – 5" L (12.7 cm) Handle

Item No.	Description	Pack	Cu. Ft.	Wt.	List Price
MP813	8" Dia. (20.3 cm)	12	0.49	10	39.00 Ea
MP914	9" Dia. (22.9 cm)	12	0.69	12	42.00 Ea
MP1015	10" Dia. (25.4 cm)	12	0.79	14	48.00 Ea
MP1116	11" Dia. (27.9 cm)	12	0.91	16	51.40 Ea
MP1217	12" Dia. (30.5 cm)	12	1.02	18	57.00 Ea
MP1318	13" Dia. (33 cm)	12	1.13	27	62.00 Ea
MP1419	14" Dia. (35.6 cm)	12	1.27	24	66.40 Ea
MP1520	15" Dia. (38.1 cm)	12	1.41	32	74.00 Ea
MP1621	16" Dia. (40.6 cm)	12	1.55	28	84.00 Ea
MP1722	17" Dia. (43.2 cm)	12	1.70	41	90.00 Ea
MP1823	18" Dia. (45.7 cm)	12	2.02	34	106.00 Ea

G

MP1015



G

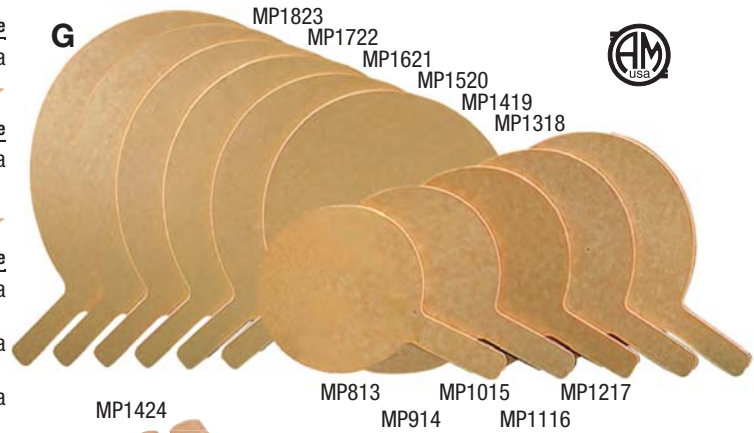

H



H) Standard Pressed Pizza Peels

Item No.	Description	Pack	Cu. Ft.	Wt.	List Price
MP1222	12" L x 14" W Blade, 9" Handle, 22" Overall (30.5 x 35.6 x 22.9 x 55.9 cm)	12	1.02	31	64.00 Ea
MP1424	14" L x 16" W Blade, 9" Handle, 24" Overall (35.6 x 40.6 x 22.9 x 60.1 cm)	12	1.33	30	80.00 Ea
MP1626	16" L x 17" W Blade, 9" Handle, 26" Overall (40.6 x 45.7 x 22.9 x 66 cm)	12	1.08	45	95.00 Ea

I) Make-Up Pressed Pizza Peel

Item No.	Description	Pack	Cu. Ft.	Wt.	List Price
MP1826	18" Sq. Blade, 8" Handle, 26" Overall (45.7 x 20.3 x 66 cm)	12	1.84	44	110.00 Ea



G9595



9525



I9540



N9494

A) Pan Grippers

Cast Aluminum Pan Gripper

Reinforced bottom curves provide better grip. Spring-loaded for easy release of pan. Designed for use with DEP, 3800, 4000, 5000, 5100, 8000 and 9000 Series pans.

Item No.	Description	Pack	Cu. Ft.	Wt.	List Price
G9595	8 1/8" L (20.6 cm)	12/72	1.25	36	11.40 Ea

Nickel-Plated Pan Grippers

Heavy-tempered steel. 9525 designed for use with shallow pans such as CAR, DEP and 4000 Series. I9540 designed for use with 3800, 5000, 5100, 8000 and 9000 Series.

Item No.	Description	Pack	Cu. Ft.	Wt.	List Price
9525	For shallow pans	12/60	0.72	28	6.00 Ea
I9540	For deep pans	12/60	0.89	26	6.00 Ea

Nylon Pan Gripper

Dishwasher-safe, high heat-resistant. Designed for use with DEP, 3800, 4000, 5000, 5100, 8000 and 9000 Series pans.

Item No.	Description	Pack	Cu. Ft.	Wt.	List Price
N9494	8 1/4" L (21 cm)	50	1.37	14	22.00 Ea



B)

B) Super Heavy-Duty Grippers

These grippers are heavy weights! 50% heavier than the 9525 or I9540. HDD94 designed for use with shallow pans such as CAR, DEP and 4000 Series. HDS95 designed for use with 3800, 5000, 5100, 8000 and 9000 Series.

Item No.	Description	Pack	Cu. Ft.	Wt.	List Price
HDD94	For shallow pans	12/60	0.73	37	16.00 Ea
HDS95	For deep pans	12/60	0.78	40	16.00 Ea



C)

C) Deep Dough Cutting Rings

Heavy-gauge stainless steel cutting ring. Permanently welded stainless handle.

Item No.	Description	Wt.	List Price
RDC6	6" Dia. x 3" H (15.2 x 7.6 cm)	1 1/4 Lb/Ea	66.00 Ea
RDC7	7" Dia. x 3" H (17.8 x 7.6 cm)	1 1/2 Lb/Ea	68.00 Ea
RDC8	8" Dia. x 3" H (20.3 x 7.6 cm)	1 3/4 Lb/Ea	71.00 Ea
RDC9	9" Dia. x 3" H (22.9 x 7.6 cm)	2 Lb/Ea	74.00 Ea
RDC10	10" Dia. x 3" H (25.4 x 7.6 cm)	2 1/4 Lb/Ea	77.00 Ea
RDC11	11" Dia. x 3" H (28 x 7.6 cm)	2 1/2 Lb/Ea	79.00 Ea
RDC12	12" Dia. x 3" H (30.5 x 7.6 cm)	2 3/4 Lb/Ea	83.00 Ea
RDC13	13" Dia. x 3" H (33 x 7.6 cm)	3 Lb/Ea	85.00 Ea
RDC14	14" Dia. x 3" H (35.6 x 7.6 cm)	3 1/4 Lb/Ea	88.00 Ea
RDC15	15" Dia. x 3" H (38.1 x 7.6 cm)	3 1/2 Lb/Ea	90.00 Ea
RDC16	16" Dia. x 3" H (40.6 x 7.6 cm)	3 3/4 Lb/Ea	94.00 Ea
RDC17	17" Dia. x 3" H (43.2 x 7.6 cm)	4 Lb/Ea	98.00 Ea
RDC18	18" Dia. x 3" H (45.7 x 7.6 cm)	4 1/4 Lb/Ea	100.00 Ea
RDC19	19" Dia. x 3" H (48.3 x 7.6 cm)	5 1/2 Lb/Ea	104.00 Ea
RDC20	20" Dia. x 3" H (50.8 x 7.6 cm)	7 Lb/Ea	106.00 Ea



RDC6



D) Standard Pizza Delivery Bags

One inch (2.54 cm) thick foam padding for insulation. Heat reflecting mylar interior reinforced with nylon for added strength. Large grommet holes for steam ventilation. Red vinyl exterior. These bags are designed to carry two boxed pizzas. Crossed carrying straps make handling easy. Materials and workmanship guaranteed.

Item No.	Description	Pack	Cu. Ft.	Wt.	List Price
PB1800	18" Sq. (45.7 cm) Holds two 16" (40.6 cm) pizza boxes	10	4.63	15	44.00 Ea
PB2000	20" Sq. (50.8 cm) Holds two 18" (45.7 cm) pizza boxes	10	4.86	24	50.00 Ea
PB2400	24" Sq. (61 cm) Holds two 22" (55.9 cm) pizza boxes	10	8.41	28	63.00 Ea

E) Deluxe Pizza Delivery Bags

The heavy nylon construction with reinforced stitching can hold up to two pizza boxes. The delivery bag contains PVC foam so your pizzas stay hot and fresh. The bag comes in red with black two-handled strap for easy carrying.

Item No.	Description	Pack	Cu. Ft.	Wt.	List Price
PBDX1805	18" Sq. x 5" H (45.7 x 12.7 cm) Holds two 16" (40.6 cm) pizza boxes	10	5.56	25	45.00 Ea
PBDX2005	20" Sq. x 5" H (50.8 x 12.7 cm) Holds two 18" (45.7 cm) pizza boxes	10	8.00	31	53.00 Ea

F) Deluxe Sandwich Delivery Bag

This sandwich bag is great for deliveries or picnics. It has nine tiny holes to allow the bag to breathe.

Item No.	Description	Pack	Cu. Ft.	Wt.	List Price
PBSB1512	15" L x 9" W x 12" H (38.1 x 22.9 x 30.5 cm)	10	6.98	25	45.00 Ea

G) Deluxe Delivery Bags with Rack

Bags have heavy nylon construction with reinforced stitching, contain PVC foam for insulation, include racks and feature a two-handled strap for carrying.

Item No.	Description	Pack	Cu. Ft.	Wt.	List Price
PB1914	19" Sq. x 14" H (48.3 x 35.6 cm) Holds up to 6 pizza boxes	1	3.76	10	240.00 Ea
PB1926	19" Sq. x 27" H (48.3 x 68.6 cm) Holds up to 10 pizza boxes	1	5.61	15	310.00 Ea

A



A) Rolling Pins and Pie Rollers

Item No.	Description	Pack	Cu. Ft.	Wt.	List Price
RP020	Wood 1 3/4" Dia. x 20" L (4.4 x 50.8 cm)	48	0.61	57	13.60 Ea
RP021	Wood 1 3/4" Dia. x 20 1/2" L (4.4 x 52.07 cm)	12	0.94	25	13.60 Ea
PR18	Wood 1 1/4" Dia. 18" L (3.18 x 45.7 cm)	48	0.33	31	6.20 Ea
RP5713	Aluminum 13" W (33 cm)	6	1.56	22	64.00 Ea
RP5715	Aluminum 15" W (38.1 cm)	6	1.56	24	68.00 Ea
RP5718	Aluminum 18" W (45.7 cm)	6	1.56	25	77.00 Ea
WRPC5713	Wood 13" W (33 cm)	3	0.50	10	70.00 Ea
WRPC5715	Wood 15" W (38.1 cm)	3	0.50	11	84.00 Ea
WRPC5718	Wood 18" W (45.7 cm)	3	0.50	13	102.00 Ea
WRPCHARDWARE	2 each extra Handles, Steel End Caps and Nylon Bearings				15.00 Set
PRP500	Stainless Steel Rolling Pin 1 3/4" Dia. x 5 1/2" W x 8 3/4" L (4.4 x 13.9 x 22.2 cm)	20	1.49	28	23.00 Ea

B) Standard Dough Boxes

Tough, white ABS construction with reinforced sides, corners and edges. Stacks securely. Interchangeable with each other and other makes. 3" (7.62 cm) and 3 1/2" (8.9 cm) deep sizes, cover fits both. Dishwasher-safe.

Item No.	Description	Pack	Cu. Ft.	Wt.	List Price
DRB18230	18" L x 26" W x 3" H (45.7 cm x 66 cm x 7.6 cm)	6	4.51	22	42.00 Ea
DRB18235	18" L x 26" W x 3 1/2" H (45.7 cm x 66 cm x 8.9 cm)	6	5.45	25	43.00 Ea
DRBC1826	Cover for Dough Pans	12	1.71	26	40.00 Ea

C) Heavy-Duty Dough Box

Premium dough boxes are manufactured from tough Teflon® co-polymer for the ultimate in non-stick. It virtually eliminates the need for pre-soaking! Cross stack lugs enable fast and secure cross-stacking. Interchangeable with most other dough boxes. Color: Warm White.

Item No.	Description	Pack	Cu. Ft.	Wt.	List Price
DBP1826	18" L x 26" W x 3 1/8" H (45.7 x 66 x 7.9 cm)	6	5.66	26	58.00 Ea

D) Deluxe Anodized Aluminum Dough Pans

Constructed of heavy 14 gauge (.064", 1.5 mm) tempered aluminum. Self stacking design. Requires minimum storage space, easily cleaned, refrigerates quickly and stacks securely. Eastern pan stacks with pans of similar shape.

Small Straight-Sided Stacking

Item No.	Description	Pack	Cu. Ft.	Wt.	List Price
DRPS5725	7" ID x 2 1/2" H (17.8 x 6.4 cm) 32 oz. (.9 L) capacity	12	1.50	9 Lb/Dz	10.40 Ea
7007	Cover for DRPS5725			4 Lb/Dz	5.90 Ea
DRPS5825	8" ID x 2 1/2" H (20.3 x 6.4 cm) 40 oz. (1.2 L) capacity			9 Lb/Dz	11.60 Ea
7008	Cover for DRPS5825			4 Lb/Dz	6.30 Ea

Standard Straight-Sided Stacking

Item No.	Description	Pack	Cu. Ft.	Wt.	List Price
DRP774	7 7/8" OD x 7 1/4" ID x 2 3/8" H (20 x 18.4 x 6.03 cm) 40 oz. (1.2 L) capacity			7 Lb/Dz	12.80 Ea
7007	Cover for DRP774			4 Lb/Dz	5.90 Ea
DRP884	9" OD x 8 3/4" ID x 3 3/8" H (22.9 x 21.3 x 8.6 cm) 80 oz. (2.4 L) capacity			9 Lb/Dz	16.00 Ea
7008E	Cover for DRP884			4 Lb/Dz	6.30 Ea

Eastern Stacking

Item No.	Description	Pack	Cu. Ft.	Wt.	List Price
DRPE800	8" OD x 7 3/8" ID x 2 5/8" H (20.3 x 18.7 x 7.6 cm) 48 oz. (1.41 L) capacity	24	2.34	14	11.00 Ea
7007E	Cover for DRPE800			4 Lb/Dz	5.90 Ea
DRPE878	8 7/8" OD x 8 1/4" ID x 3 1/4" H (22.5 x 20.9 x 8.9 cm) 96 oz. (2.8 L) capacity	24	3.34	17	13.60 Ea
7008E	Cover for DRPE878			4 Lb/Dz	6.30 Ea

E) Pizza Oven Brush with Brass Bristles and Steel Scraper

Heavily filled (65 tufts) stiff brass wire on one side and rust-proof steel scraper on the other. Screw type handle with extra strong die cast aluminum threaded tip for easy attachment to 10" x 1 3/4" (25.4 x 4.5 cm) hardwood block.

Item No.	Description	Pack	Cu. Ft.	Wt.	List Price
1597	Complete Brush and 40" Handle (101.6 cm)	12	1.99	31	38.00 Ea
1698	Complete Brush and 60" Handle (152.4 cm)	1	0.36	3	47.00 Ea
1597H	Replacement Brush Only	12/36	2.72	47	29.00 Ea
159740	40" (101.6 cm) Handle Only	12	0.47	9	12.00 Ea
159760	60" (152.4 cm) Handle Only	12	0.54	14	17.00 Ea

F) Stirring Paddles

Stainless Steel Paddles

One-piece seamless paddles feature a 4 3/4" x 9 3/4" (12.1 x 24.8 cm) blade. 1" (2.54 cm) tubular handle.

Item No.	Description	Pack	Cu. Ft.	Wt.	List Price
2124	24" L (61 cm)	12	0.80	21	27.80 Ea
2130	30" L (76.2 cm)	12	0.98	23	30.00 Ea
2136	36" L (91.4 cm)	12	0.85	24	34.00 Ea
2142	42" L (106.7 cm)	12	1.35	28	38.00 Ea
2148	48" L (121.9 cm)	12	1.07	29	43.00 Ea
2154	54" L (137.2 cm)	12	2.04	34	47.00 Ea

Hard Wood Stirring Paddles

Smoothly sanded hard wood, with a rectangular tapered blade. Blade measures 4" wide x 7/8" thick (10.2 x 2.2 cm). 1 1/4" (3.2 cm) wide handle.

Item No.	Description	Pack	Cu. Ft.	Wt.	List Price
240	24" L (61 cm)	12	0.63	9	18.60 Ea
300	30" L (76.2 cm)	25	1.30	23	20.80 Ea
360	36" L (91.4 cm)	12	1.01	13	22.20 Ea
420	42" L (106.7 cm)	25	2.02	29	25.40 Ea
480	48" L (121.9 cm)	25	1.91	33	28.80 Ea

